

# SS4 User Manual



## 4CH 1080P MDVR(Standard Configuration)

Thank you for using our Mobile DVR. Please read this User's Manual carefully to ensure that you can use the device correctly and safely.

The contents of this manual are subject to change without notice.

V1.4

# Contents

1 Specifications .....	1
2 Precautions.....	3
3 Main Features.....	4
4 Wiring Diagram.....	6
5 Connection - Front Panel.....	7
5.1 Mechanical Lock.....	7
5.2 LED .....	8
5.3 Remote Controller .....	8
5.4 SSD Slot.....	9
5.5 SD Card Slot .....	9
5.6 USB Slot.....	9
6 Connection - Back Panel .....	9
6.1 Power .....	10
6.2 Cameras (AVIN 1~4).....	10
6.3 LCD Monitor .....	11
6.4 Buzzer.....	12
6.5 Alarm, Speed Interface.....	13
6.6 Three-in-one Antenna (GPS, 2G/3G/4G, Wi-Fi).....	15
7 The Menu .....	15
7.1 Menu Introduction.....	15
7.2 Menu Lock.....	17
7.3 Keyboard Operation Instruction .....	19

7.4 Manual Recording .....	21
7.5 Playback.....	21
7.6 Log .....	26
7.7 Display Mode Switching .....	26
7.8 System .....	26
7.9 Disk .....	27
7.10 Volume .....	28
8 Record Setup.....	29
8.1 Power On Rec .....	29
8.2 Cyclic Rec .....	29
8.3 Event Rec.....	29
8.4 Video Quality .....	30
8.5 Record Channel .....	32
8.6 IPC Setup.....	33
8.7 Event Duration.....	36
8.8 File Length.....	36
8.9 Motion Sensitivity .....	36
8.10 G-Force Sensitivity .....	37
8.11 File Type.....	44
8.12 Record Audio.....	44
9 Display.....	45
9.1 Camera Display Setting .....	45
9.2 Camera Name Setting .....	46

9.3 System Language Setting.....	46
9.4 Audio Out .....	47
9.5 OSD Display Setting.....	47
9.6 Menu on .....	48
9.7 Speed.....	48
9.8 GPS.....	49
9.9 Mirror.....	50
9.10 System Format Setting .....	51
10 Network .....	53
10.1 LAN and Server Setting.....	53
10.2 Wi-Fi Network Setup and Server Setup .....	55
10.3 2G/3G/4G Control and Setup .....	57
10.4 AP Internet Setup .....	59
10.5 Network Status .....	59
10.6 Server.....	61
10.7 File Upload .....	61
10.8 RTSP Streaming.....	65
11 System.....	66
11.1 Log in Setup .....	66
11.2 License Plate Number Setup .....	67
11.3 System Time Setup .....	67
11.4 Scheduled Recording .....	70
11.5 Exception.....	70



11.6 ACC Settings.....	71
11.7 Alarm Information Setting .....	72
11.8 Update.....	75
11.9 Configuration .....	77
11.10 Application Setting.....	78
11.11 System Info .....	93
12 FAQ .....	94
13 APPENDIX .....	95
APPENDIX I : Abbreviation & Description .....	95
APPENDIX II : Accessories .....	96
APPENDIX III: Compatibility Storage List.....	97

# 1 Specifications

4CH 1080P DVR		
System	Operating system	Linux
	Operating interface	Graphical menu operation interface (OSD)
	Video permission	Administrator & user setting
Video	Video input	4 x 1080P analog high definition
	CVBS output	1CH 6pin aviation connector output PAL/NSTC
	Video display mode	Single/Split/Triple/Quad/8 Cam/9 Cam/Black Screen display
	Video standard	PAL: 25fps, NTSC: 30fps
	Compression	H.264 main profile
Audio	Audio input	4 channels
	Audio output	2 channels
	Record format	Synchronized video & audio recording
	Audio compression	ADPCM
Digital processing & storage	Image resolution	Max 4 x 1080P(1920 x 1080)
	Video bit rate	64kbps~4Mbps/channel
	Storage	56~1800MB/(channel/hour)
	Audio bit rate	32kbps
	Storage	SD card x 1(Max. 512GB), SSD x 1(Max. 2TB)
Alarm	Alarm input	6 channels
	Alarm output	2 channels, 1 buzzer
	Motion detection	High/Low/Off sensitivity adjustable
Interface for communication	IR	1 channel
	RJ45	1 channel
	USB2.0	1 channel
Wireless	2G / 3G / 4G	Optional
	Wi-Fi	Optional
	Wi-Fi hotspot / AP	Optional

GPS	Optional	
G-Force /Gyroscope	3 axis sensor	Available
Software	Windows client	Available
	IOS client	Available
	Web portal	Available
Power	Input	10~32V
	Output	12V@4A
	Max power consumption	48W
	Standby power consumption	100mW
Electrical	Operating temp. / humidity	-20°C ~ +70°C / <80%
	Super capacitor	Available
	Clock	Built-in clock, Calendar
	Algorithm	DMS/ADAS/BSD/AVM
Others	Waterproof grade	IP69K
	Anti-vibration grade	MIL-STD-810G

## 2 Precautions

- 1) Motion detection function is set to OFF by default. Alarm files will be created when the motion detection is set ON.
- 2) G-Force recording is recommended to set ON during driving for emergency recording use. G- Force level is optional.
- 3) If the device could not boot up, try to remove all storage disks from the device, and then restart it to check whether it could boot normally or not.
- 4) Should: ACC wire should be connected to the ignition wire, two VCC wires to the positive pole of the battery and two ground wires to the negative pole. Shouldn't: ACC and two VCC wires should not be connected to the ignition wire, and two ground wires should not be connected to the negative pole of the battery, otherwise it may lead to the damage of the disk and the recording files. Prohibit: ACC and two VCC wires are prohibited to be connected to the positive pole of the battery and two ground wires to the negative pole. In this case, the battery would be run out quickly.
- 5) All the disks must be formatted on the device before they are put into use.
- 6) The users' name could not be changed, while the password is editable.
- 7) All types of video files including event recording files are overwritten by default.
- 8) The corresponding types of SENSOR-IN1~6 on the trigger line are as follows:

SENSOR-IN1	SENSOR-IN2	SENSOR-IN3	SENSOR-IN4	SENSOR-IN5	SENSOR-IN6
Alarm Input 1~4				Reversal Input	Brake Input

- 9) The disk must be installed appropriately and well connected, otherwise the device would not work properly.
- 10) GPS antenna, 2G/3G/4G antenna, Wi-Fi antenna must be connected correctly and tighten.
- 11) If DVR does not have GPS, WIFI and 4G, the time cannot be automatically calibrated, and the difference will be about 10min in a year.
- 12) If more accurate time is required, user needs to manually perform time calibration.

## 3 Main Features

### Controlled by touch screen

- All settings and operations could be done through a touch-control monitor.

### Video and Audio

- 4 x 1080P video inputs.
- 4 x audio inputs.
- 2 x audio outputs.
- 2 video outputs (1 x CVBS -6pin, 1 x VGA-1080P).

### Recording

- 4CH Video & Audio Recorder with image resolution up to 1920 x 1080, G- Force data and GPS data.
- Multiple recording modes: power on recording, normal recording, schedule recording and event recording (i.e., G- Force recording, overspeed recording, motion detection recording, alarm recording 1~6 and Panic button recording, radar detection alarm recording, inappropriate drivers' action warning recording, driving safety risk recording FCW alarm, DMS detection alarm, Lane departure warning alarm, BSD detection alarm), cyclic recording and 15 seconds pre-recording are also supported.
- Recording files are stored in the SSD or SD card.
- Real-time recording of license plate numbers, driving speed, G- Force/Gyroscope 3D accelerated speed, longitude and latitude, and GPS tracking.

### Preview and Playback

- Support single channel or 4 channels audio and video playing back simultaneously.
- Support searching recording files by dates and recording types.
- Support to control the time during playing back.
- Indicating recording status, alarm status and etc.

### Storage Types

- Support 1 x SSD (2TB) and 1 x SD card (512GB, SDHC, SDXC).
- SSD is preferred. SD card could be put into use if there is no SSD connected/detected.
- SD card can be easily removed from DVR.

## Backup

- Support USB disk or USB hard disk to backup the recording files.

## Network

- Support LAN, Wi-Fi, and 2G / 3G / 4G.
- LAN, Wi-Fi and 2G / 3G / 4G have the sequence priority of connections. They are automatically switched to save the data once LAN, Wi-Fi or 2G/3G/4G is connected.
- Recording files could be uploaded to the server. Files are able to be searched/downloaded by CMS Client.
- Wi-Fi supports STATION and AP mode. Wi-Fi AP mode enables mobile devices to be connected, and users could use mobile devices to preview and configure conveniently.
- Support remote real-time video streaming and previewing.
- Support automatic uploading of alarm recording files, alarm information, log information and GPS trajectory, which is convenient to analyze any abnormal conditions of vehicles and track the vehicle.
- Support remote configuration and remote upgrading.
- Support PC Windows Client, mobile iOS and Android app. Users could remotely monitor vehicles by computers or mobile phones.

## Alarm

- 6 channels of alarm inputs, 1 channel of buzzer output and 2 channels of alarm outputs.
- Overspeed alarm.
- Motion detection alarm.
- G-Force alarm.
- Panic button alarm.
- DMS alarm (no driver, fatigue, distraction, phone call, smoke, no mask, no seatbelt, sunglass).
- ADAS alarm (Forward collision warning, Pedestrian detection warning, Lane departure warning).
- BSD alarm.

## Security

- Users' password protection. The device could not be accessed without password.
- Support account management.

# 4 Wiring Diagram

- Output wiring the method of VGA display :

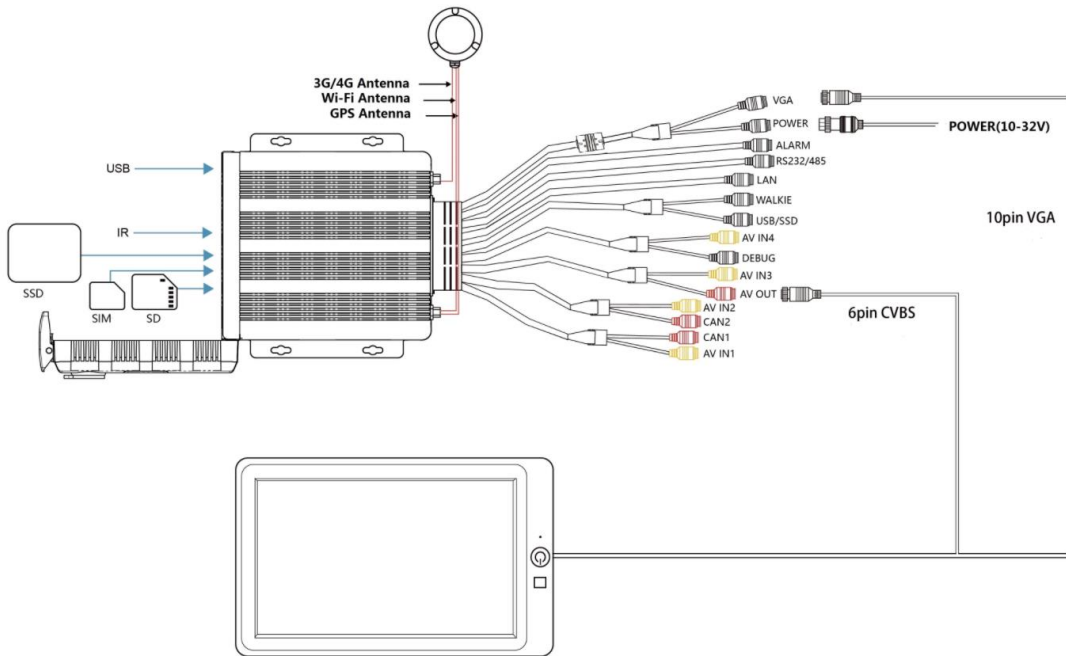

- Output wiring the method of CVBS/AHD display :

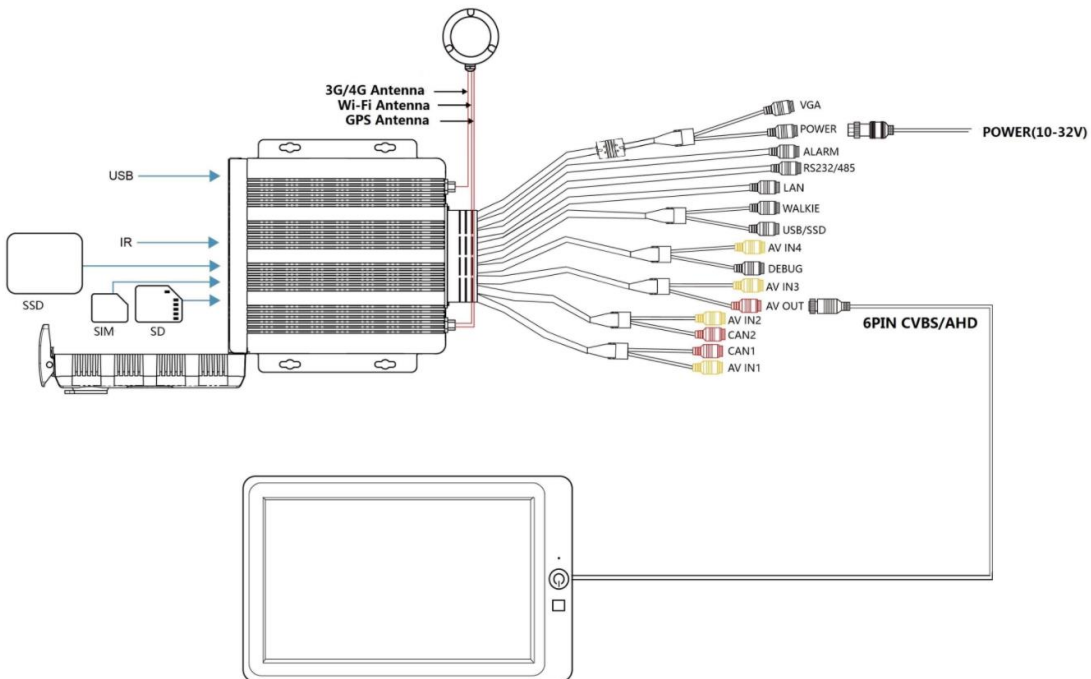

- Front and rear panel view :

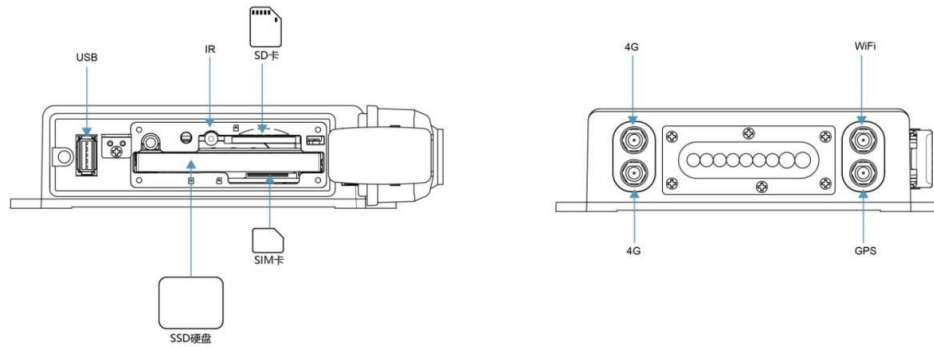

## 5 Connection - Front Panel

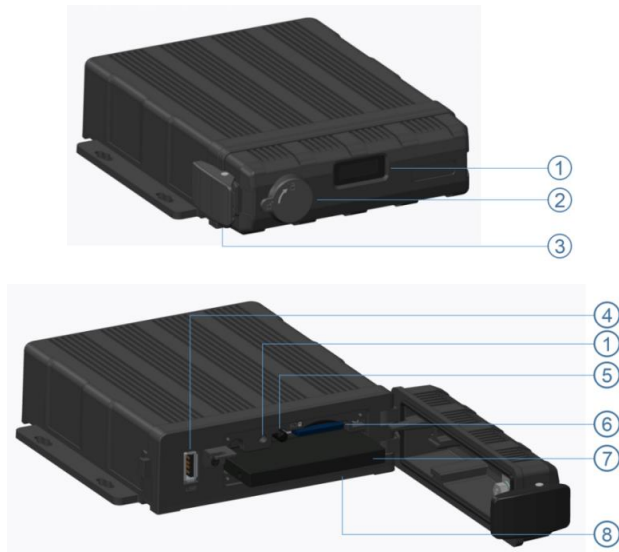

- |                   |                 |
|-------------------|-----------------|
| ① LED Indicator   | ⑤ IR receiver   |
| ② Mechanical Lock | ⑥ SD Card Slot  |
| ③ SSD Lock Cover  | ⑦ SSD Slot      |
| ④ USB2.0 Port     | ⑧ SIM Card Slot |

### 5.1 Mechanical Lock

- Close the front cover, lock the buckle, and then lock the device with the key.
- The device will stop recording and the buzzer will beep when the front cover is open, If the front cover is still open or the electronic lock is not closed after 2 minutes, DVR will resume recording.



## 5.2 LED

- When DVR is working normally, the red light is always on and the green light is flashing.
- When upgrades the DVR firmware, the red light is on and the green light is off.

## 5.3 Remote Controller

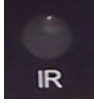

Use the remote controller closer enough to the IR Receiver, otherwise it may not work.

Description	Buttons	
Useless -reserved	POWER	
Switch to ch1~8 for single channel display	1~8	
Switch to eight-segment display	0	
Enter menu	MENU	
Move up	Up	
Move to left	Left	
Enter sub menu to set and confirm	ENTER	
Useless -reserved	REC	
Move down	Down	
Exit	ESC	
Move to right	Right	
Useless -reserved	MULTI	
Clear input	CLEAR	

## 5.4 SSD Slot

1 x SSD (Max. 2TB ).

- Size: 2.5 inches.

## 5.5 SD Card Slot

- 1x SD (Max. 512GB).
- Insert, remove the SD card.

Step 1: Use the key to unlock the device and open front cover.

Step 2: Insert SD card to SD card slot.

Step 3: Close the front cover and use the key to lock.

## 5.6 USB Slot

USB 2.0

# 6 Connection - Back Panel

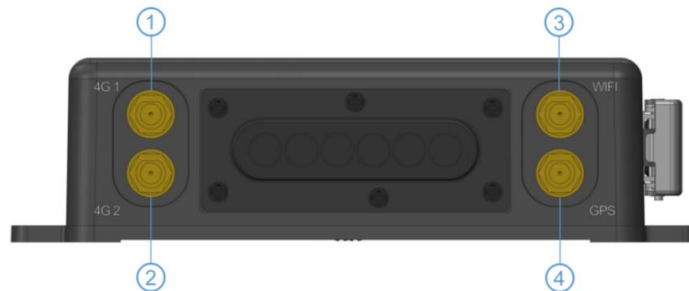

① 2G/3G/4G antenna 1

③ Wi-Fi antenna

② 2G/3G/4G antenna 2

④ GPS antenna

## 6.1 Power

- Power input



Connect the 9 PIN female to the 9 PIN male on the device.

- Connection Method

Connect ignition wire to yellow ACC, battery Positive to V+ (Red wire) and Negative to GND (black wire).

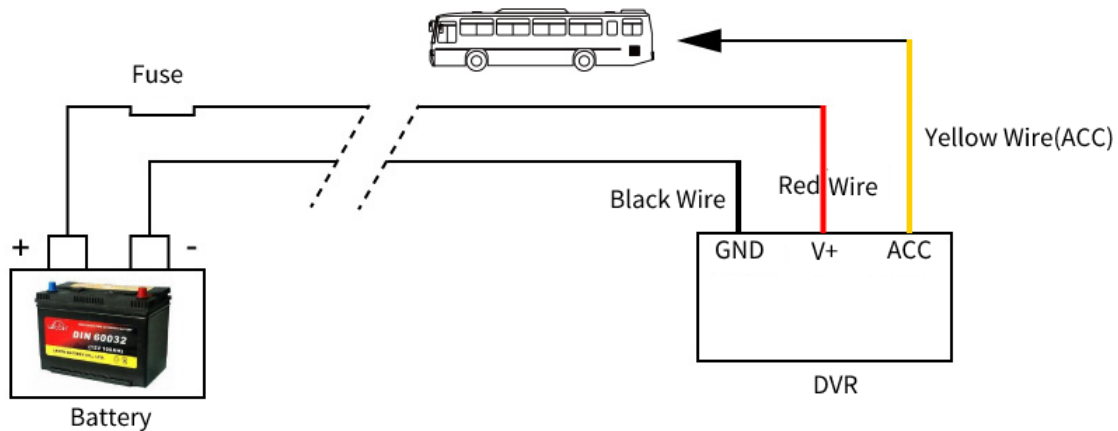

## 6.2 Cameras (AVIN 1~4)

- Below is the definition of camera input (male).

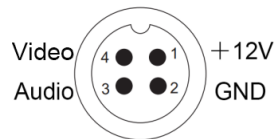

- How To Connect Cameras

Connect 4 cameras on below cable which connects to back plate of DVR.

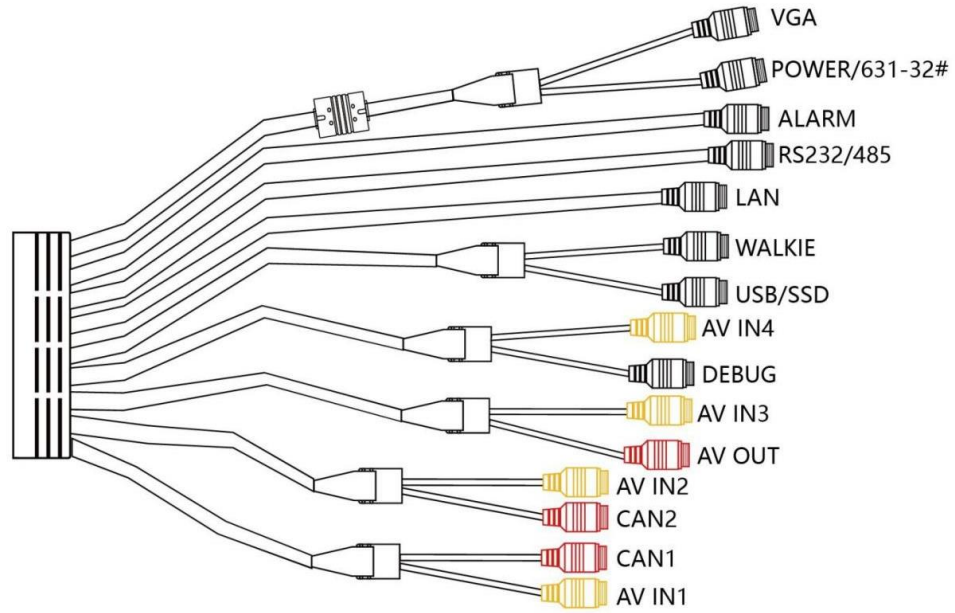

### 6.3 LCD Monitor

- High definition monitors are recommended to work with the device as below.



- Output resolution of the LCD monitor can be selected. Settings are as follows.

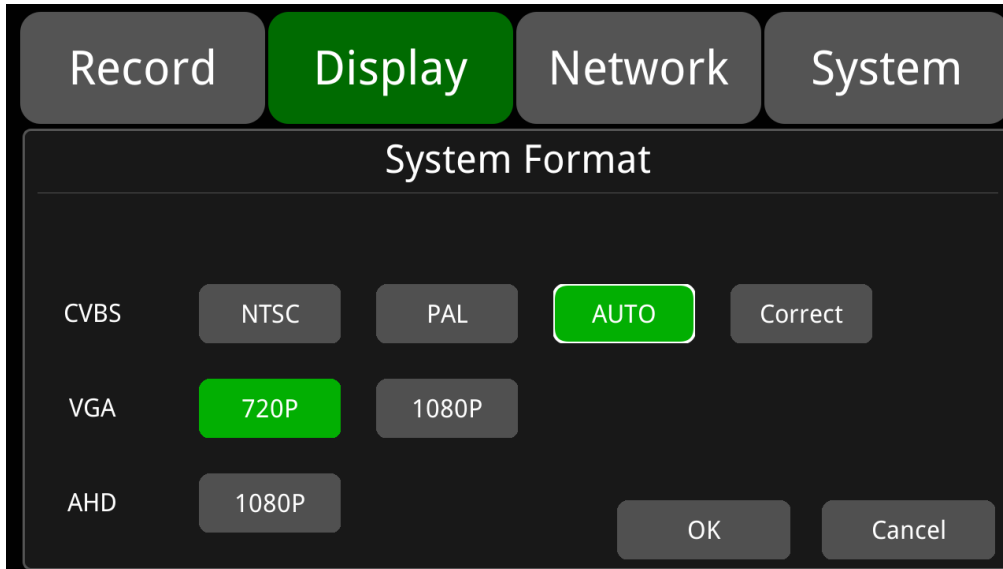

AUTO supports as below.

System Format		
CVBS	VGA	AHD
NTSC/PAL/ AUTO	1080P/720P	1080p

## 6.4 Buzzer

If the device is not connected to a monitor, please check the recording status by the buzzer.

The buzzer would alarm if the device is not recording under Normal Mode which is set by default. To stop the buzzer from alarming, please make sure the device is working properly.

The buzzer warning function is as follows.

- The buzzer will keep beeping for a while for all types of alarm event recording.
- If the buzzer alarm is not needed, users can go to “System - Exception” page, and set Buzzer from ON to OFF. And please note that if the Buzzer is set to be OFF, there would be no alarm even if any event is triggered.

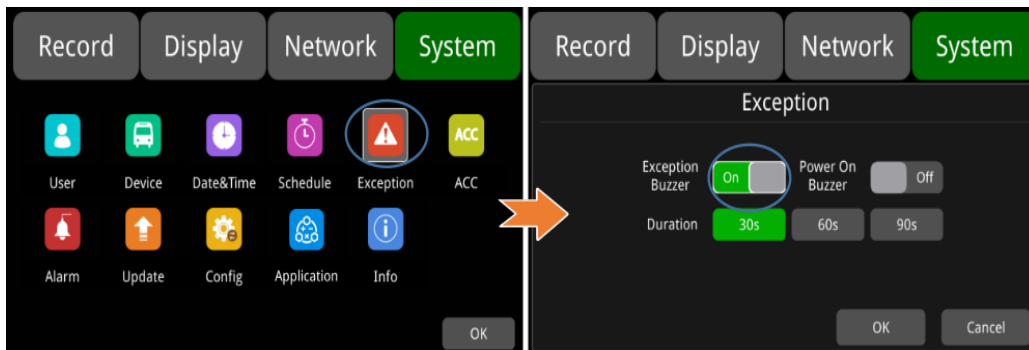

- Power On Buzzer: DVR beeps, when it is set to ON.it beeps 15 times when it is powered on; when it is set to off, there is no beep when it is turned on.

If the buzzer beeps intermittently, it means that the device is unable to record.

Different beeping modes stand for different working status as below.

- 1) The front cover is open: one long beep and one short beep.
- 2) No disk: one long beep and two short beeps.
- 3) Abnormal disk system: one long beep and three short beeps.
- 4) If the disk is operating normally, the video file is full, and the Cyclic Rec. is off: two short beeps and one short beep.
- 5) No camera input: two short beeps, and two short beeps after a second.
- 6) If the disk is well connected but the device is not in recording: two short beeps and three short beeps.

## 6.5 Alarm, Speed Interface

- Alarm, Speed Interface Cable

See the picture below.

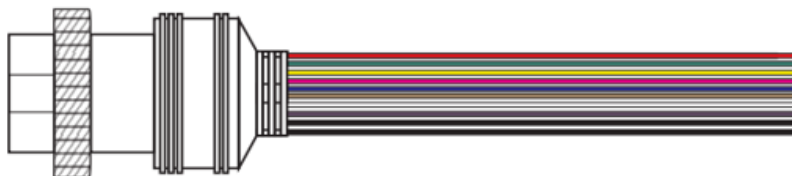

● Pin Definition

10 PIN	1	2	3	4	5	6	7	8	9	10
Color	Red	Pink	Blue	Grey	White	Purple	Green	Yellow	Black	Black
Definition	Alarm out2	Alarm out1	Alarm _in6	Alarm _in5	Alarm _in4	Alarm _in3	Alarm _in2	Alarm _in1	GND	GND
Definition	Alarm output2	Alarm output1	Alarm input6	Alarm input5	Alarm input4	Alarm input3	Alarm input2	Alarm input1	Ground	Ground

- 1) There are 6 alarm inputs including alarm inputs 1 ~ 4, reversal input, brake input, which can trigger the alarm recording. Cursor will be displayed when the alarm input channel is working. The first 4 ones can be self-defined by user.

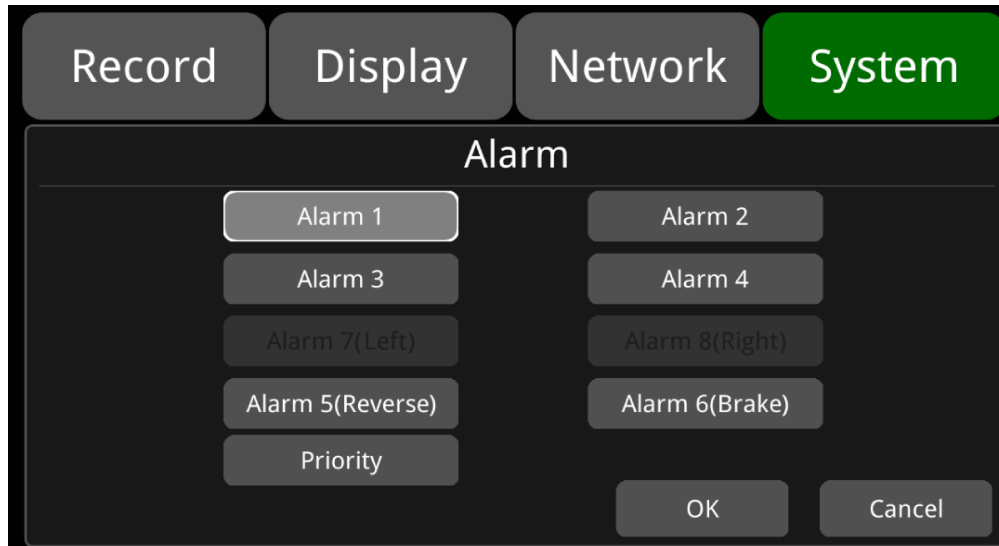

- 2) Alarm output 1 is 12V by default, which can be used as a trigger and working together with alarm inputs. You can also set up the BUZZER as one output.
- 3) If Alarm input 1 is active and combined with Alarm output 1, the Alarm output 1 will output a high-level voltage to trigger other device.

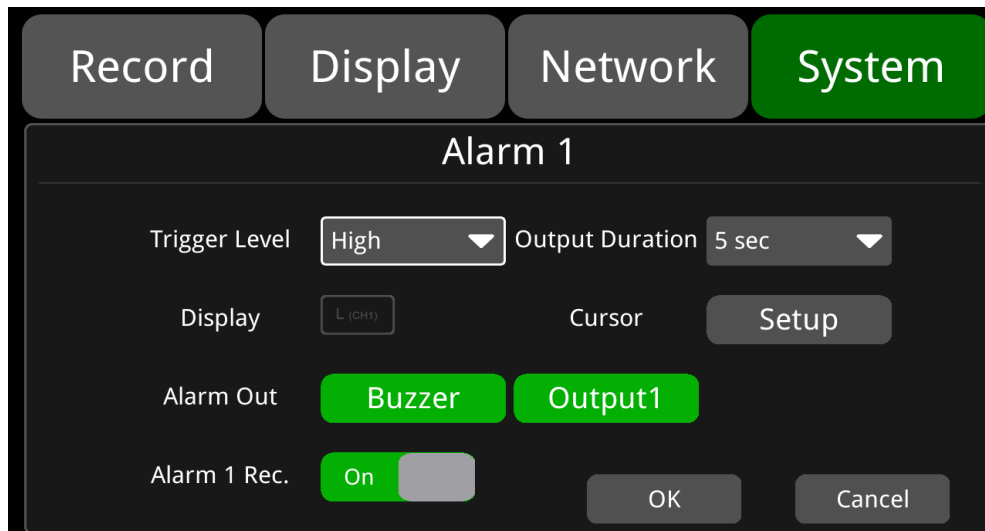

## 6.6 Three-in-one Antenna (GPS, 2G/3G/4G, Wi-Fi)



# 7 The Menu

## 7.1 Menu Introduction

Press [MENU] on the remote control or touch the bottom area on a connected LCD screen, the Menu will be shown as below. Please log in before entering the menu.



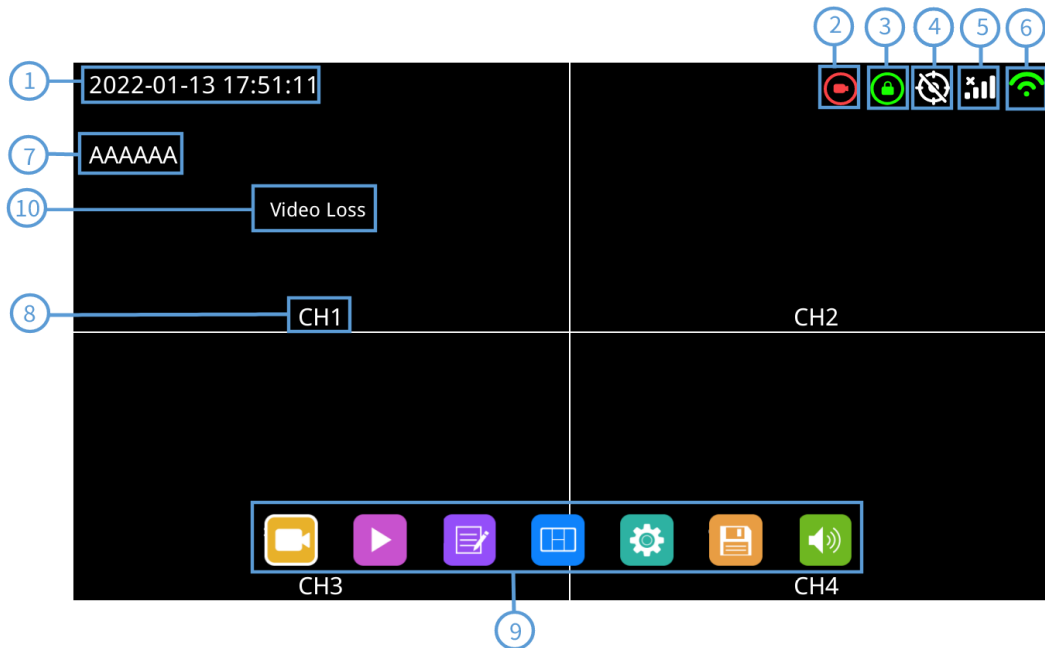

- ① System time display.
- ② Recording.
  - When the front cover is closed, the lock indicator turns green.
  - Mechanical lock is different from menu lock.
- ③ Lock.
  - When the front cover is closed, the lock indicator turns green.
  - Mechanical lock is different from menu lock.
- ④ GPS.
  - It flashes in connection process, and when connected, led is always on.
- ⑤ 2G/3G/4G.
- ⑥ Wi-Fi.
- ⑦ License plate number display.
- ⑧ Channel name.
- ⑨ Menu.
  - Click the position of area 9 to display the menu icons.
- ⑩ Video loss.

## 7.2 Menu Lock

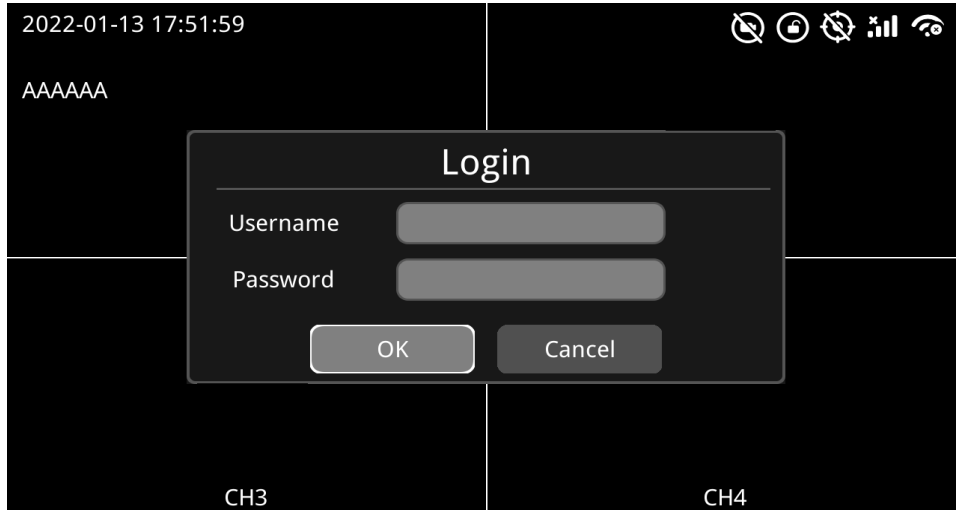

- The device/recorder supports two kinds of permissions: admin permission and guest permission.
- Users' account list.

	Admin Permission	Guest Permission
User Name	admin	guest
Password Modification	Yes	No
Initial Password	123	321
Permission	Enter all menus	Enter the menu of Playback, Display mode switching and Volume

- Users' name could not be changed, but users' password is changeable. Guest does not have permission to enter the setup menu, so the password cannot be changed. (See the following instructions to change the password.)

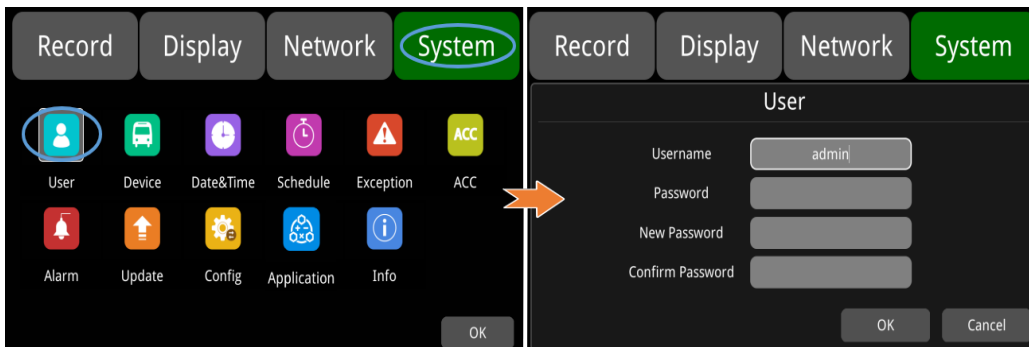

- Only the administrator could change the status of Menu lock. The following picture shows how to change the Menu Lock status from ON to OFF.

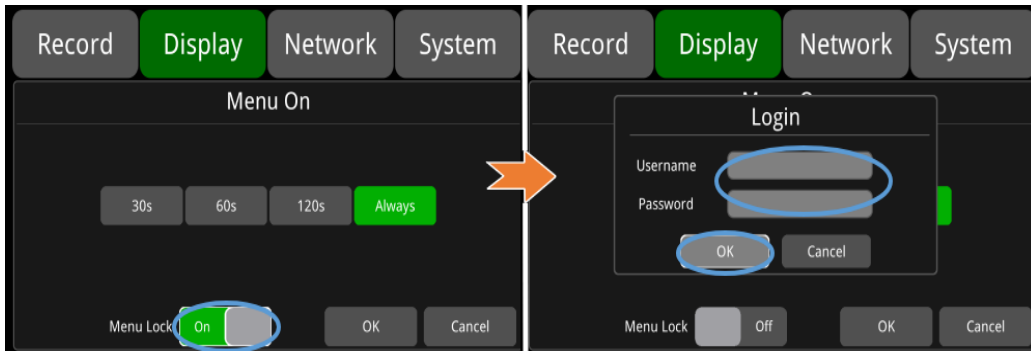

- When the menu lock status is "ON", you need to enter the user name "admin" and password to enter the "recording", "play", "log", "settings", "disk" "layer switching" and "volume adjustment" and other menus. If you use the user name "guest" and password, you can only enter the "play", "layer switching" and "volume adjustment" menu. When the menu lock status is "Off", you do not need to enter the user name and password to enter the menu.

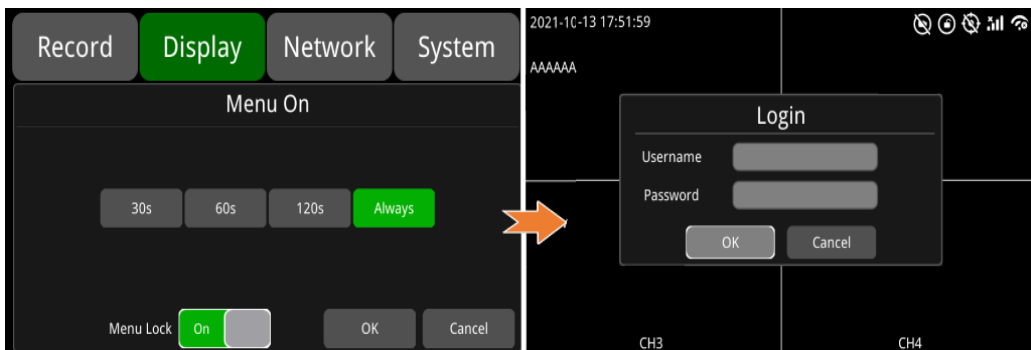

## 7.3 Keyboard Operation Instruction

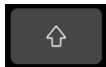
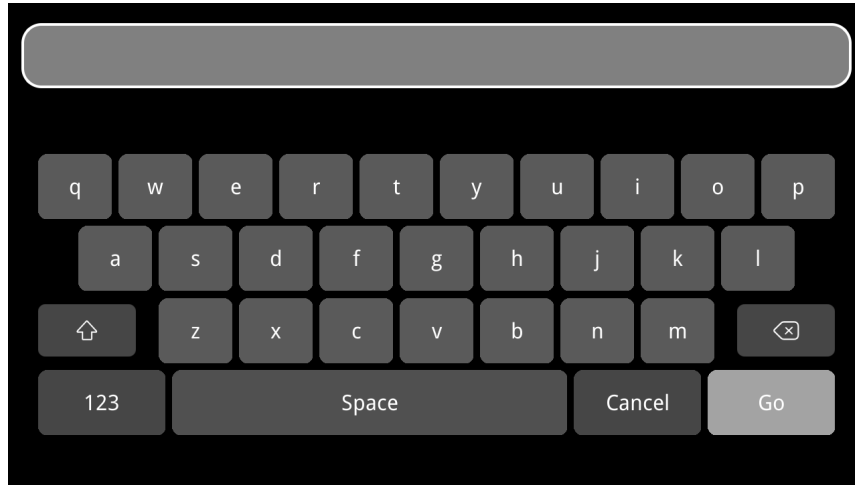

: Switch letter case.

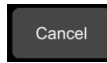

: Exit without saving changes.

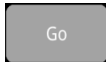

: Exit with saving changes.



: Clear input.

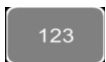

: Switch to the numeric interface.

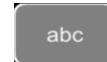

: Switch to the English alphabet interface.

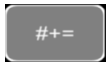

: Switch to the special character interface.

## Character Switching Introduction

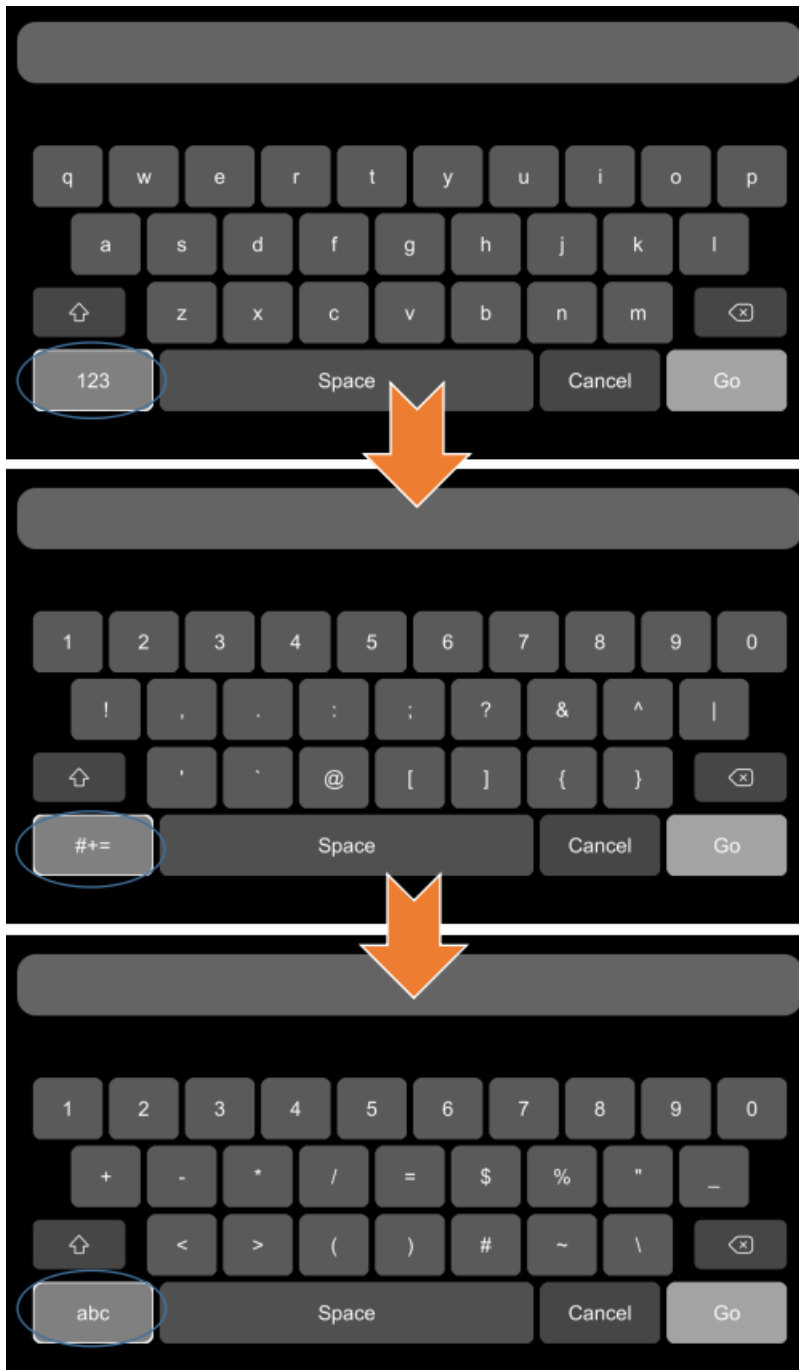

## Letter Case Switching Introduction

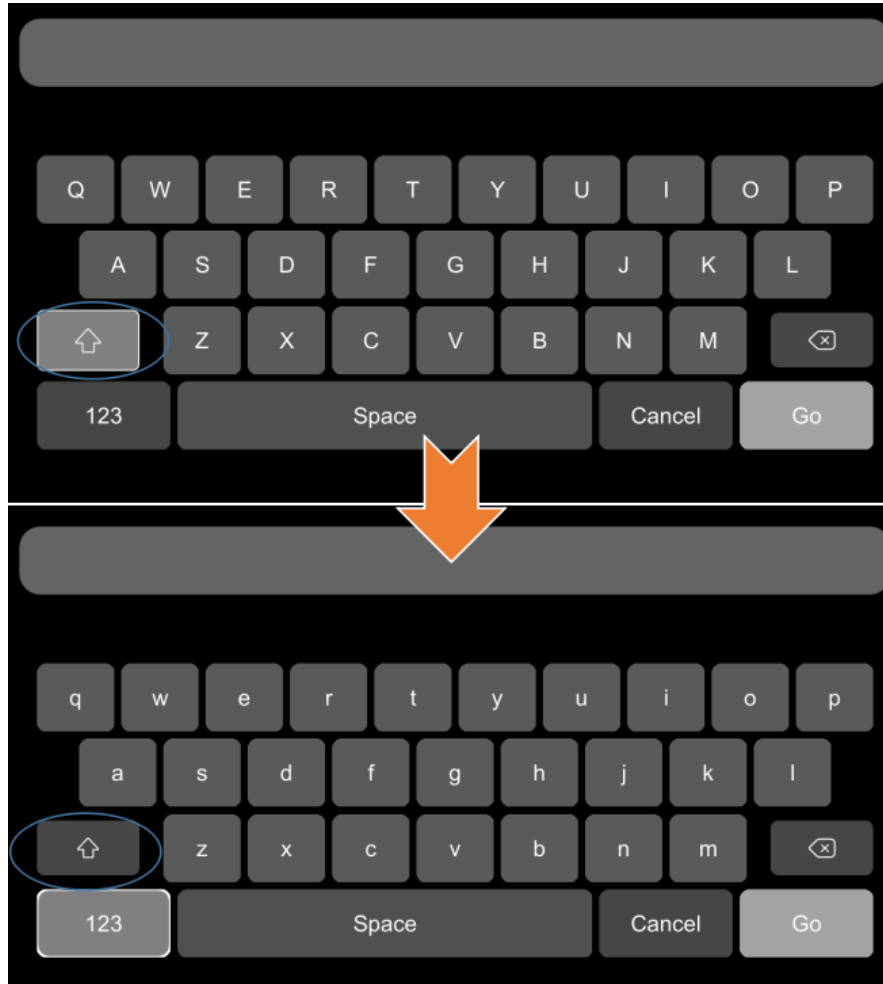

## 7.4 Manual Recording



Recording icon: This version is mandatory to record, so clicking this button can not close and open the record

## 7.5 Playback



Video Playback button: Touch this icon to enter the calendar menu.

Green marked date means it has recording files saved on that day. Select the date to enter the video file list, then select the file and touch Play icon to play video. You can select single or multiple videos at a time. Multiple videos can be played in sequence and can be shifted to the next or the previous one. Specific operation is as below.

- Calendar Interface

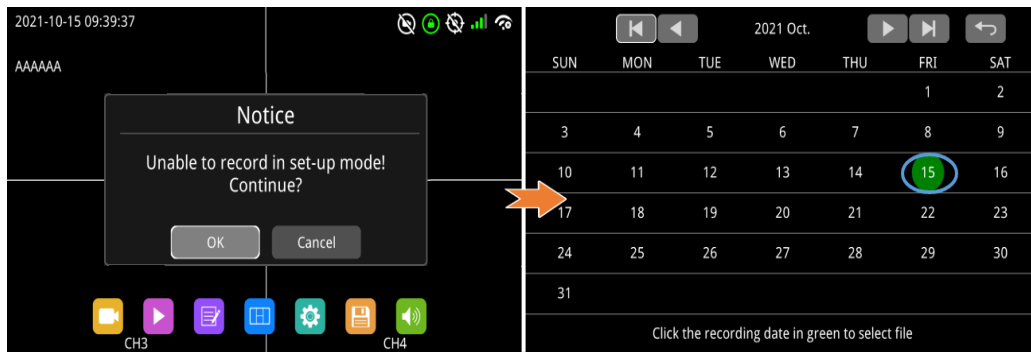

◀ ▶ : Search by month.

◀ ▶ : Search by year.

- Record List Interface (1)

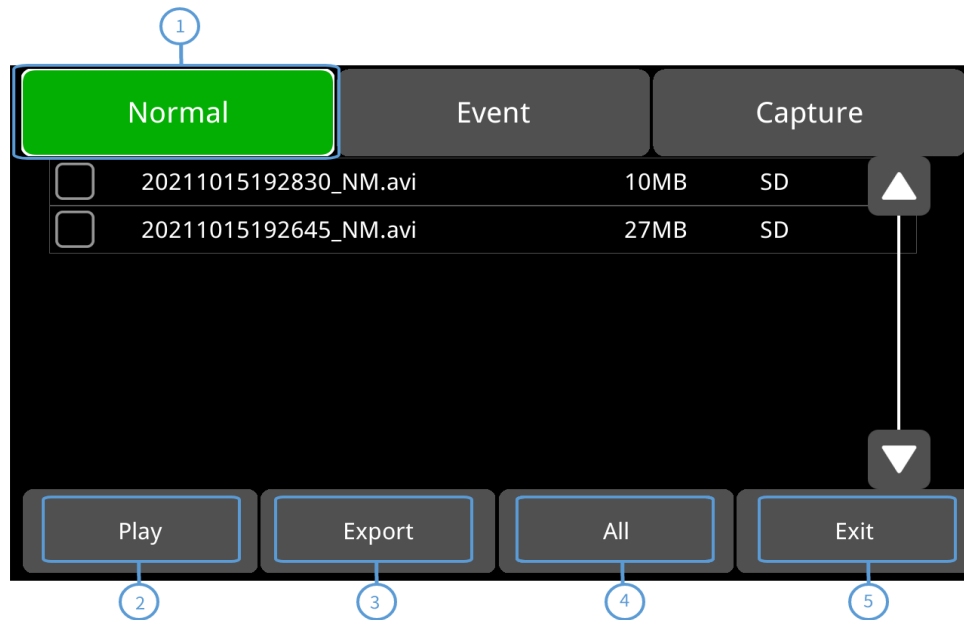

- ① Normal: Recording list, including normal recording, boot recording, timing recording, alarm recording 1~6, motion detection alarm recording, G-Force alarm recording, overspeed alarm recording, panic button manual recording alarm, FCW alarm, DMS detection alarm, LANE departure detection alarm, PDS detection Alarm, BSD detection alarm.

Type	Recording Time Control Mode	View Position
Normal recording	Manual control	Normal list
Power on recording	Manual control	Normal list
Schedule recording	Pre-setup time	Normal list
Alarm recording 1~6	Event recording setup time	Normal list
Motion detection recording	Event recording setup time	Normal list
G-Force recording	Event recording setup time	Normal list
Overspeed recording	Event recording setup time	Normal list
Panic button recording	Event recording setup time	Normal list
FCW alarm	Event recording setup time	Normal list
DMS detection alarm	Event recording setup time	Normal list
LANE departure alarm	Event recording setup time	Normal list
PDS departure alarm	Event recording setup time	Normal list
BSD departure alarm	Event recording setup time	Normal list

② Play: Play the selected video files.

③ Export: Export selected video files to external USB devices.

④ All: Select all seven files on current page.

⑤ Exit: Exit.

● Record List Interface (2)

There is an abbreviation of record type in the file name, from which you can get the record type of this file. Only .NM video files are generated in the local playback files, and the abbreviations of other video types can be viewed in the client.



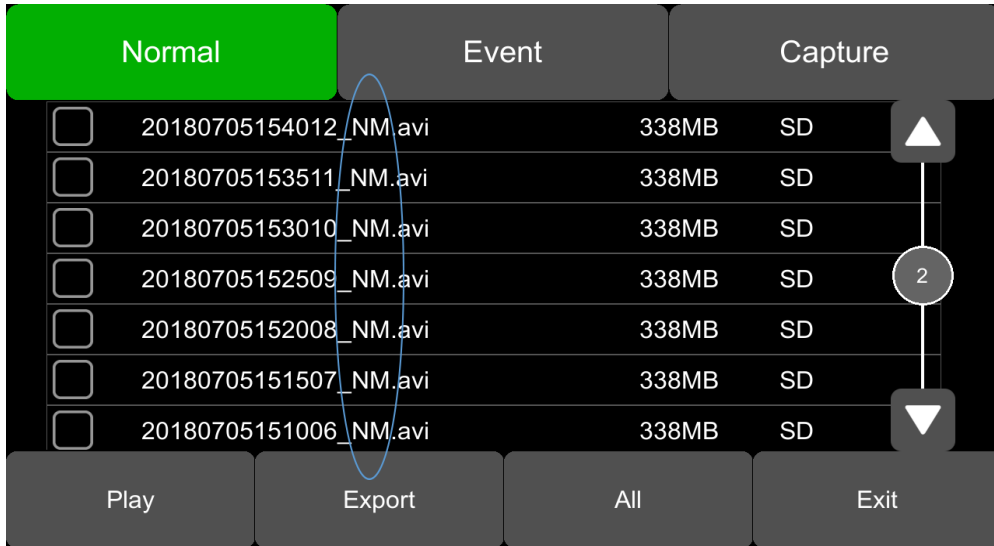

The alarm recording file uploaded to the client is shown in the figure below.

Device	Plate No	Begin Time	End Time	Status	Percent	Doc...	File Size...	File Type	File Name	File Posit...
55555-455-00013(2107220017)	55555-455-00013	2021-10-25 22:03:46	2021-10-25 22:04:05	Not Down...	0%	3		brake	20211025140346_*.01.avi	Media Ser...
	55555-455-00013	2021-10-25 22:03:46	2021-10-25 22:04:05	Not Down...	0%	3		brake	20211025140346_*.03.avi	Media Ser...
	55555-455-00013	2021-10-25 22:03:54	2021-10-25 22:04:13	Not Down...	0%	3		brake	20211025140354_*.02.avi	Media Ser...
	55555-455-00013	2021-10-25 22:03:54	2021-10-25 22:04:13	Not Down...	0%	11		brake	20211025140354_*.04.avi	Media Ser...
	55555-455-00013	2021-10-25 22:03:54	2021-10-25 22:04:13	Not Down...	0%	3		brake	20211025140354_*.01.avi	Media Ser...
	55555-455-00013	2021-10-25 22:06:16	2021-10-25 22:06:35	Already Do...	100%	3		smoking	20211025140616_*.02.avi	Media Ser...
	55555-455-00013	2021-10-25 22:06:16	2021-10-25 22:06:35	Not Down...	0%	3		smoking	20211025140616_*.01.avi	Media Ser...
	55555-455-00013	2021-10-25 22:06:16	2021-10-25 22:06:35	Not Down...	0%	11		smoking	20211025140616_*.04.avi	Media Ser...
	55555-455-00013	2021-10-25 22:06:16	2021-10-25 22:06:35	Not Down...	0%	3		smoking	20211025140616_*.03.avi	Media Ser...
	55555-455-00013	2021-10-25 22:07:59	2021-10-25 22:08:12	Already Do...	100%	7		gsensor	20211025140759_*.04.avi	Media Ser...
	55555-455-00013	2021-10-25 22:07:59	2021-10-25 22:08:13	Not Down...	0%	2		gsensor	20211025140759_*.01.avi	Media Ser...
	55555-455-00013	2021-10-25 22:07:59	2021-10-25 22:08:13	Not Down...	0%	2		gsensor	20211025140759_*.03.avi	Media Ser...
	55555-455-00013	2021-10-25 22:07:59	2021-10-25 22:08:13	Not Down...	0%	2		gsensor	20211025140759_*.02.avi	Media Ser...
	55555-455-00013	2021-10-25 22:13:59	2021-10-25 22:14:14	Not Down...	0%	3		motion	20211025141359_*.01.avi	Media Ser...
	55555-455-00013	2021-10-25 22:13:59	2021-10-25 22:14:14	Not Down...	0%	9		motion	20211025141359_*.04.avi	Media Ser...
	55555-455-00013	2021-10-25 22:13:59	2021-10-25 22:14:14	Not Down...	0%	3		motion	20211025141359_*.02.avi	Media Ser...
	55555-455-00013	2021-10-25 22:13:59	2021-10-25 22:14:14	Not Down...	0%	3		motion	20211025141359_*.03.avi	Media Ser...
	55555-455-00013	2021-10-25 22:16:31	2021-10-25 22:16:34	Not Down...	0%	1		alarm2	20211025141631_*.01.avi	Media Ser...
	55555-455-00013	2021-10-25 22:16:31	2021-10-25 22:16:34	Already Do...	100%	1		alarm2	20211025141631_*.03.avi	Media Ser...
	55555-455-00013	2021-10-25 22:16:31	2021-10-25 22:16:34	Not Down...	0%	2		alarm2	20211025141631_*.04.avi	Media Ser...
	55555-455-00013	2021-10-25 22:16:31	2021-10-25 22:16:34	Not Down...	0%	1		alarm2	20211025141631_*.02.avi	Media Ser...
	55555-455-00013	2021-10-25 22:16:39	2021-10-25 22:16:47	Not Down...	0%	2		alarm2	20211025141639_*.03.avi	Media Ser...
	55555-455-00013	2021-10-25 22:16:39	2021-10-25 22:16:47	Not Down...	0%	5		alarm2	20211025141639_*.04.avi	Media Ser...
	55555-455-00013	2021-10-25 22:16:39	2021-10-25 22:16:47	Not Down...	0%	2		alarm2	20211025141639_*.01.avi	Media Ser...
	55555-455-00013	2021-10-25 22:16:39	2021-10-25 22:16:47	Not Down...	0%	2		alarm2	20211025141639_*.02.avi	Media Ser...
	55555-455-00013	2021-10-25 22:20:01	2021-10-25 22:20:14	Already Do...	100%	2		distraction	20211025142001_*.03.avi	Media Ser...
	55555-455-00013	2021-10-25 22:20:01	2021-10-25 22:20:14	Not Down...	0%	7		distraction	20211025142001_*.04.avi	Media Ser...
	55555-455-00013	2021-10-25 22:20:01	2021-10-25 22:20:14	Not Down...	0%	2		distraction	20211025142001_*.01.avi	Media Ser...
	55555-455-00013	2021-10-25 22:20:01	2021-10-25 22:20:14	Not Down...	0%	2		distraction	20211025142001_*.02.avi	Media Ser...

The alarm recording file downloaded from the client is shown in the figure below.

🚨 2021102513593\_ MO\_0015650\_0002206068\_0704\_0480\_25\_01048576\_0000000000AAAAAA\_02\_2107220017\_04\_433\_0000000\_V02\_000\_E08\_0.avi  
 🚨 2021102514031\_ A1\_0016967\_0009072474\_1920\_1080\_25\_04194304\_0000000000AAAAAA\_04\_2107220017\_04\_446\_0000000\_V02\_000\_E08\_0.avi  
 🚨 2021102514034\_ A6\_0019969\_0002741342\_0704\_0480\_25\_01048576\_0000000000AAAAAA\_02\_2107220017\_04\_448\_0000000\_V02\_000\_E08\_0.avi  
 🚨 2021102514061\_ SM\_0019920\_0002808426\_0704\_0480\_25\_01048576\_0000000000AAAAAA\_02\_2107220017\_04\_473\_0000000\_V02\_000\_E08\_0.avi  
 🚨 2021102514075\_ GS\_0013899\_0007151268\_1920\_1080\_25\_04194304\_0000000000AAAAAA\_04\_2107220017\_04\_461\_0000000\_V02\_000\_E08\_0.avi  
 🚨 2021102514163\_ A2\_0003637\_0000528498\_0704\_0480\_25\_01048576\_0000000000AAAAAA\_03\_2107220017\_04\_173\_0000000\_V02\_000\_E08\_0.avi  
 🚨 2021102514200\_ DS\_0013275\_0001864154\_0704\_0480\_25\_01048576\_0000000000AAAAAA\_03\_2107220017\_04\_304\_0000000\_V02\_000\_E08\_0.avi

The abbreviations of recording types are as follows.

NM	Normal recording	TI	Scheduled recording
MO	Motion detection recording	SP	Speed recording
TP	Temperature recording	BT	Panic button recording
A1	Alarm 1 recording	A2	Alarm 2 recording
A3	Alarm 3 recording	A4	Alarm 4 recording
A5	Reverse recording	A6	Brake recording
PB	Pedestrian detection recording	CR	Collision alarm recording
SK	Lane deviation alarm recording	OS	Over speed recording (the speed source is ADAS)
GS	G-Force recording (easy mode)	ND	No driver alarm recording
FT	Fatigue alarm recording	DS	Distraction alarm recording
CA	Phone using alarm recording	SM	Smoking alarm recording

- Play Interface

After selecting files, press "Play" button to play the files.

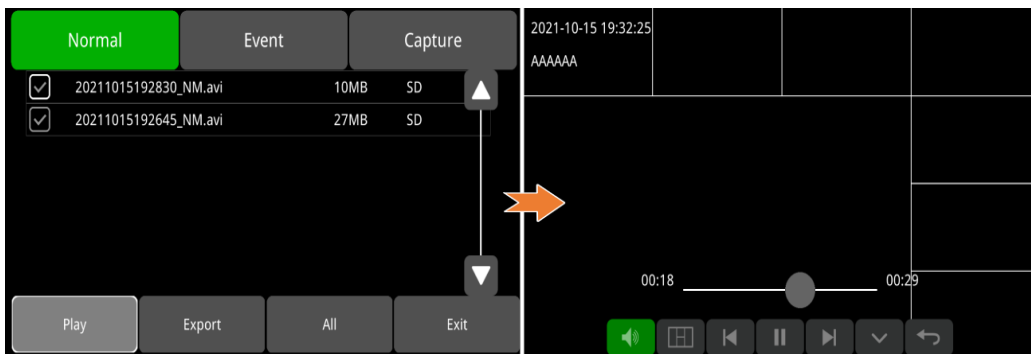

: Volume control.



: Select the playback view modes.



: Play the previous/next video file.



: Pause/Resume playing.



: Hide the menu. Press [Area 1] to display.



: Exit playing.

## 7.6 Log



System Log checking, Log export.

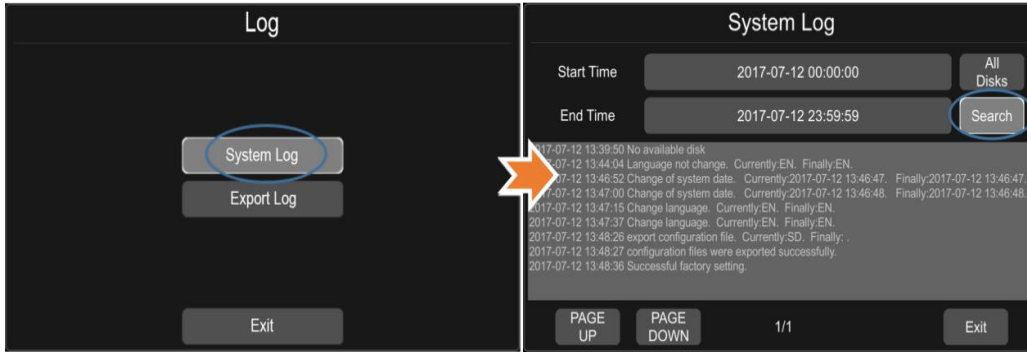

## 7.7 Display Mode Switching



Display mode switch: Press the icon to display multiple types of mode. The default mode is automatic view.

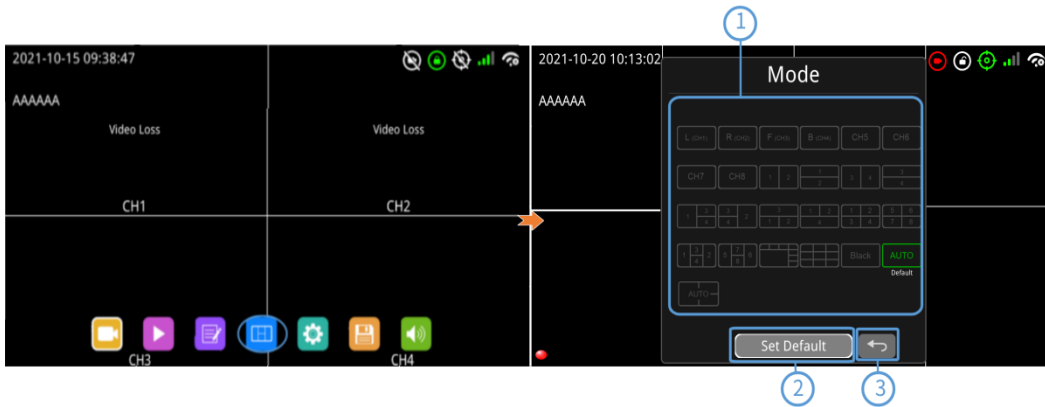

① Display mode selection.

② Touch the icon to set up the default.

③ Exit.

## 7.8 System



System settings: Touch the icon to enter the setup menu. A window warning "Unable to record in set-up mode! Continue?" will be popped up, and touch OK to enter.

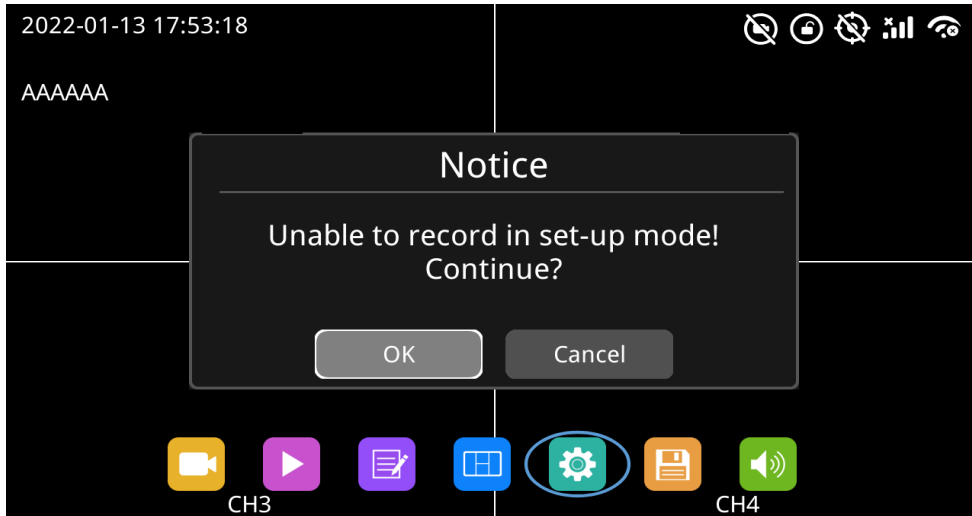

## 7.9 Disk



Disk management: Touch the icon, then you can view the status of SSD, SD card and USB storage as below.

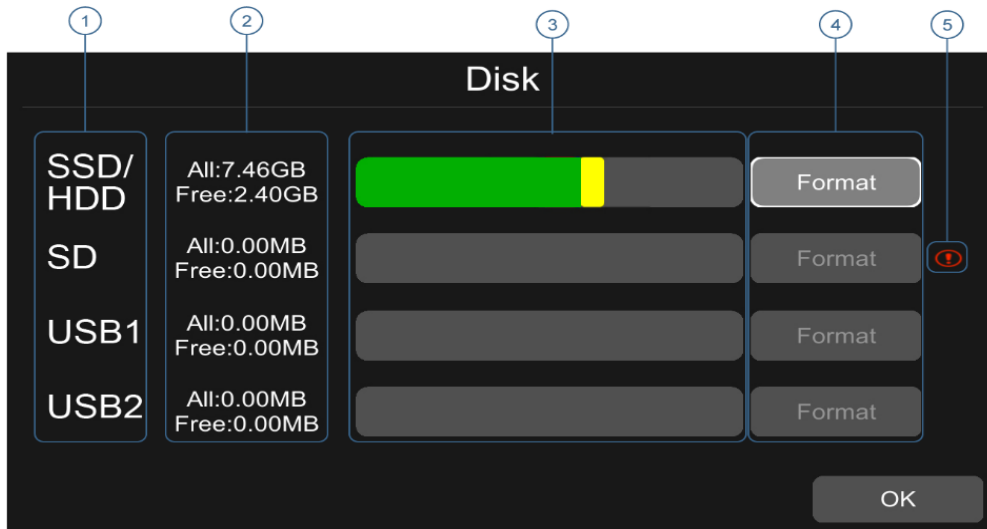

- ① Disk types.
- ② ALL: The total capacity of individual disk, free: The remaining capacity of disk.  
If ALL shows 0.00MB, it means that DVR does not have access to this type of disk.
- ③ Disk capacity bar  
Green shows the size of all video files in the "Normal" list.  
Yellow shows the size of all other files except the above files.
- ④ Touch to format the disk.

- A window text of “Disk data will be deleted! Continue?” will pop up. Press OK to start formatting the disk.
- The following picture is an example of formatting USB2.

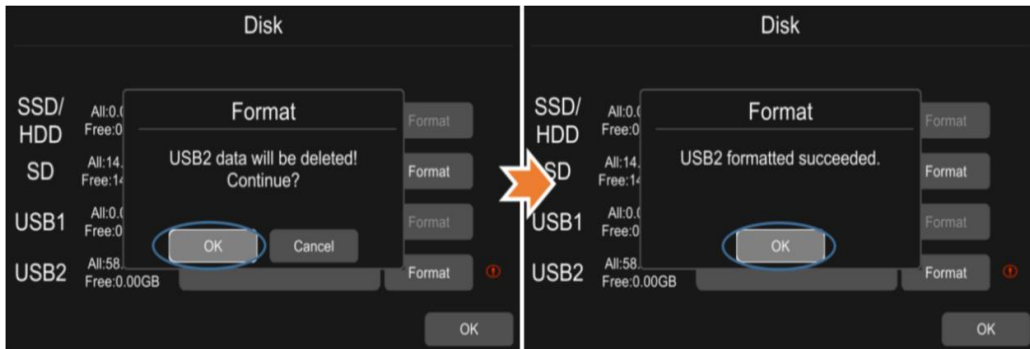

- If the disk could not be formatted, please check if there is a disk in the slot.
- ⑤ It shows that the disk needs to be formatted before application.
- All new disks must be formatted before application.

## 7.10 Volume



Volume: value 0~10, the default value is 7.

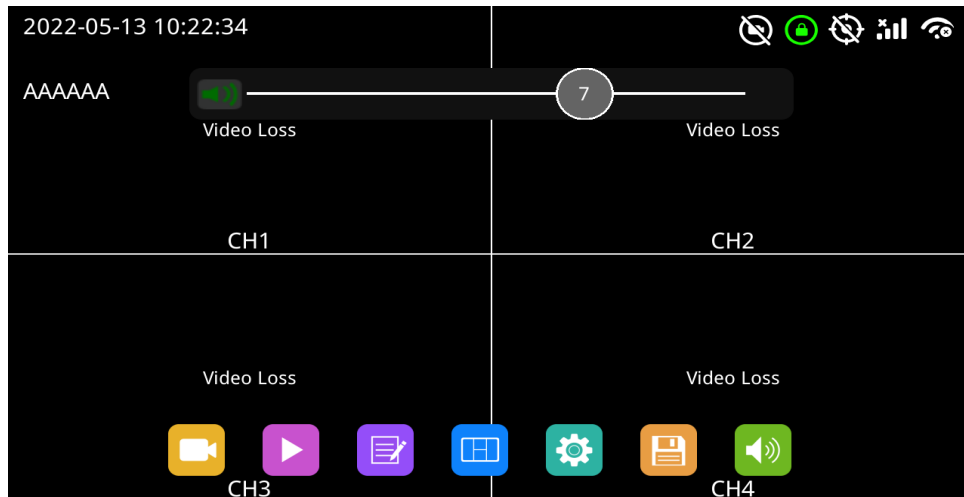

Function	Min.	Max.	Default
Volume	0	10	7

# 8 Record Setup

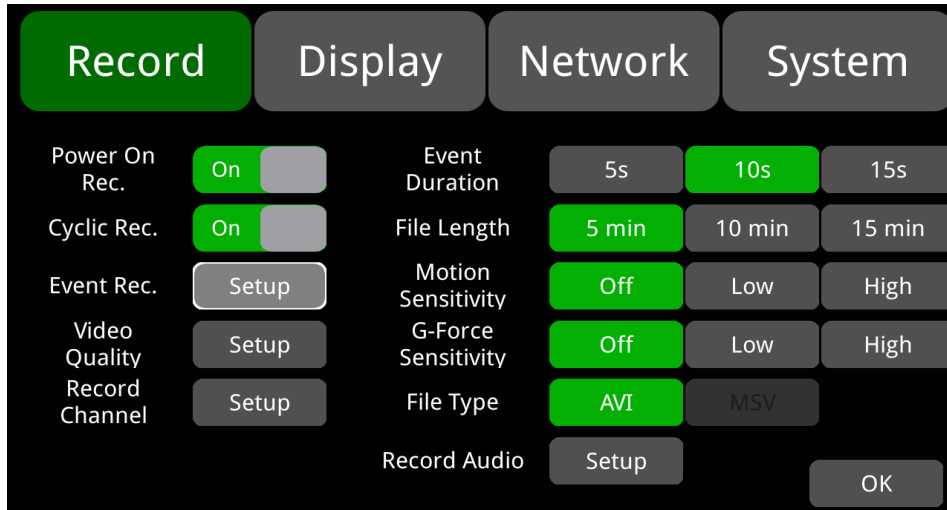

## 8.1 Power On Rec



When "Power On Rec" is set to ON, the device will start recording once it's powered on. Default setting is ON.

## 8.2 Cyclic Rec



When "Cyclic Rec" is set to ON, new recording files will overwrite the previous ones when the disk is full. Otherwise, it will stop recording when the disk is full.

This function is "ON" by default, and will overwrite all video files, including event video files.

## 8.3 Event Rec



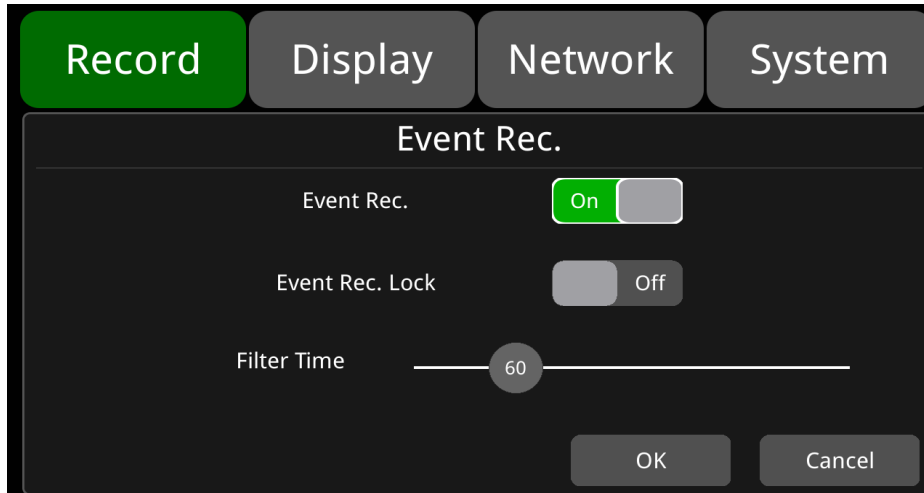

**Event Rec.:** Event recording refers to the alarm recording triggered by events including motion detection, G-Force, alarm 1 ~ 6, panic button and over speed, FCW alarm, DMS detection alarm, LANE departure alarm. If the Event Rec is set to ON and corresponding alarm parameters are set, event recording will be activated when the events above are triggered. If the Event Rec is set to OFF, event recording will not be activated even if an alarm is triggered. This function is “ON” by default.

**Event Rec. Lock:** reserved.

**Filter Time:** Time filtering. As shown in the figure, if the same alarm is triggered continuously, the DVR generates an alarm message every 60s and checks whether a new alarm recording is generated every 60s. After the DVR is connected to the Internet, the alarm information will be sent to the server. Filter Time minimum setting 1s, the maximum can be set to 300s, the default value is 60s.

## 8.4 Video Quality

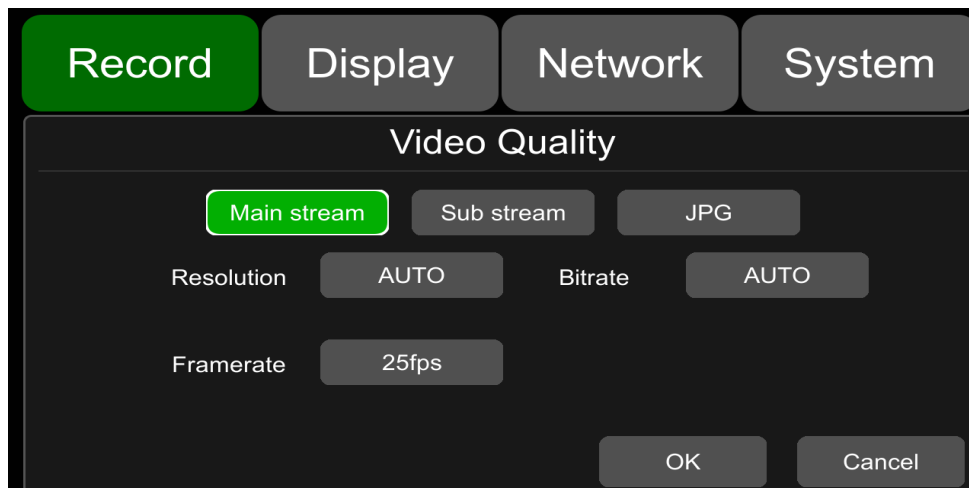

The main stream is used for video storage. The sub stream is used for network transmission.

The default configuration of main stream, sub stream and JPG are as follows.

	Main stream	Sub stream	JPG
Resolution	AUTO	CIF	None
Bitrate	AUTO	64Kbps	None
Frame rate	25fps	25fps	Low

① Resolution

Here are 5 optional resolutions in the main stream menu, 1080P, 720P, D1 (PAL), D1 (NTSC), AUTO.

The sub-stream menu defaults to CIF and it is not selectable. The higher the resolution, the better the quality of the video file and the larger the video file. Therefore, the file size should be considered during configuration.

In the options of Resolution, AUTO is defined as follows.

	Main stream
AUTO	DVR will recognize the camera format, and will record videos of that format.

② Bitrate

There are 8 levels of bitrate to choose from in the main stream menu, 4Mbps, 2Mbps, 1Mbps, 512Kbps, 256Kbps, 128Kbps, 64Kbps, AUTO; in the sub stream menu, there are 6 levels of bit rate to choose from, 1Mbps, 512Kbps, 256Kbps, 128Kbps, 64Kbps and AUTO. The higher the bit rate, the clearer the image and the larger the video file. Therefore, all factors should be considered in the options of Bitrate, AUTO is defined as follows.

Bitrate		
	Main stream	Sub stream
AUTO	If a 1080P camera is connected, the bit rate will be 4Mbps. For a 720P camera, it'll be 2Mbps. And for a D1 camera, it'll be 1Mbps.	Whatever cameras are connected, the bit rate will always be 64Kbps.

③ Frame rate

There are 8 kinds of optional frame rates in Main stream and Sub stream menu: 30fps(NTSC), 28fps (NTSC), 25fps, 20fps, 15fps, 14fps, 10fps and 5fps. The higher the frame rate is and the smoother the picture is, the larger the video file will be. (Note: mixed connection of camera with different frame rates is not allowed.)



SSD/ SD Capacity	Video Quality	File Length
2TB	4 x 1080P / 4Mbps	≈298h
	4 x 720P / 2Mbps	≈596h
	4 x D1 / 1Mbps	≈1193h
	1 x 1080P / 4Mbps	≈1193h
	1 x 720P / 2Mbps	≈2387h
	1 x D1 / 1Mbps	≈4772h
512GB	4 x 1080P / 4Mbps	≈75h
	4 x 720P / 2Mbps	≈149h
	4 x D1 / 1Mbps	≈298h
	1 x 1080P / 4Mbps	≈298h
	1 x 720P / 2Mbps	≈596h
	1 x D1 / 1Mbps	≈1193h

④ JPG

JPG Frame rate optional Excellent, High, Mid, Low. The meaning of these four values is as follows.

Excellent	The rate of uploading pictures to the client is unlimited (the fastest), and the rendering effect is the smoothest
High	The rate of uploading pictures to the client is 1 second
Mid	The rate of uploading pictures to the client is 3 second
Low	The rate of uploading pictures to the client is 5 second

## 8.5 Record Channel



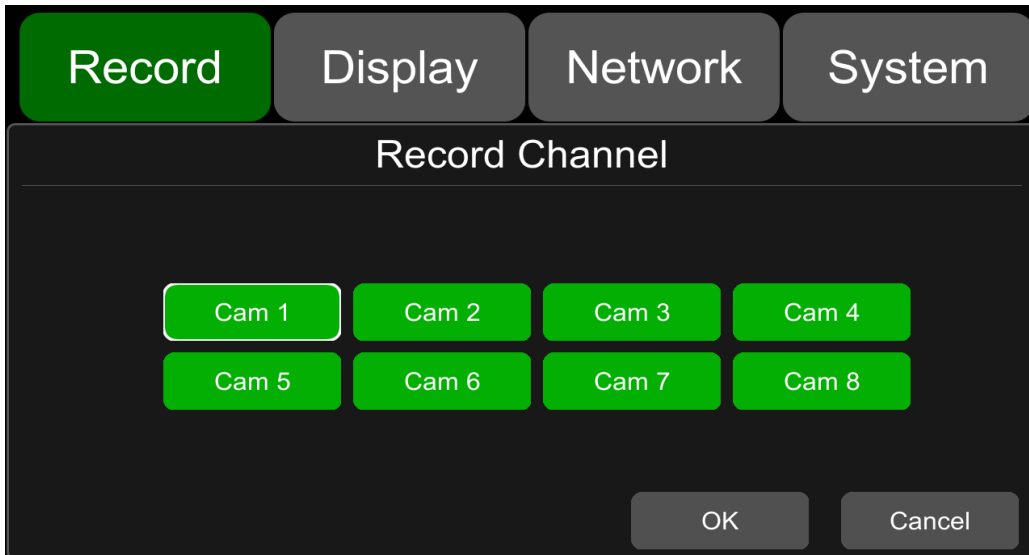

The default configuration is shown above.

Select the recording channel. When recording is turned on (including all types of recording), all channels will be recorded; this version fixed recording, turn off the recording channel, the corresponding recording channel will still be recorded.

## 8.6 IPC Setup

The default configuration is shown in the picture.

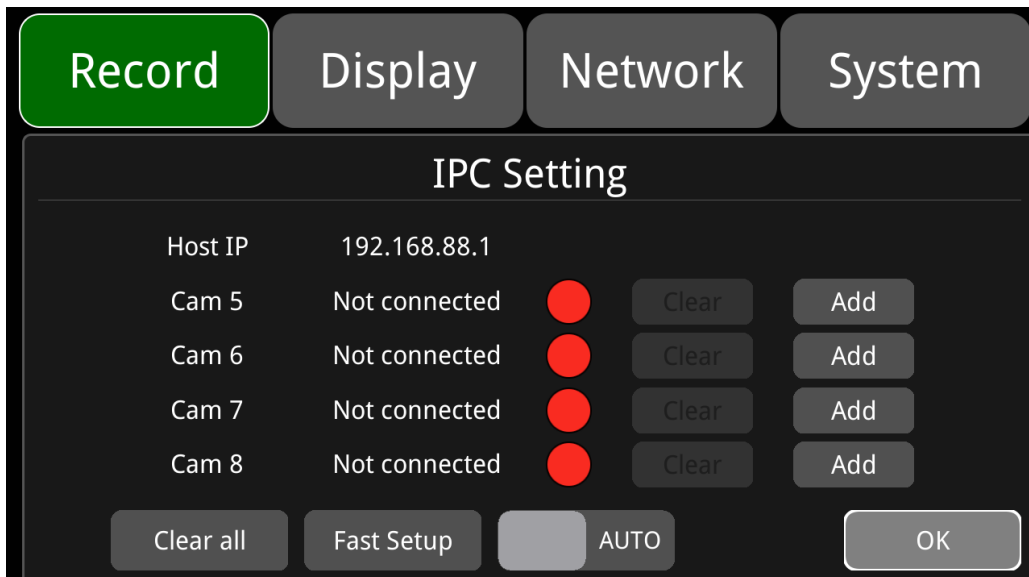



The default Host IP of the DVR is 192.168.88.1. The IPC can be applied when it is connected to the same network as the DVR. One DVR can connect up to 4 IPC channels.

AUTO: AUTO is OFF by default. When it is turned on, the detected IPC is automatically connected.

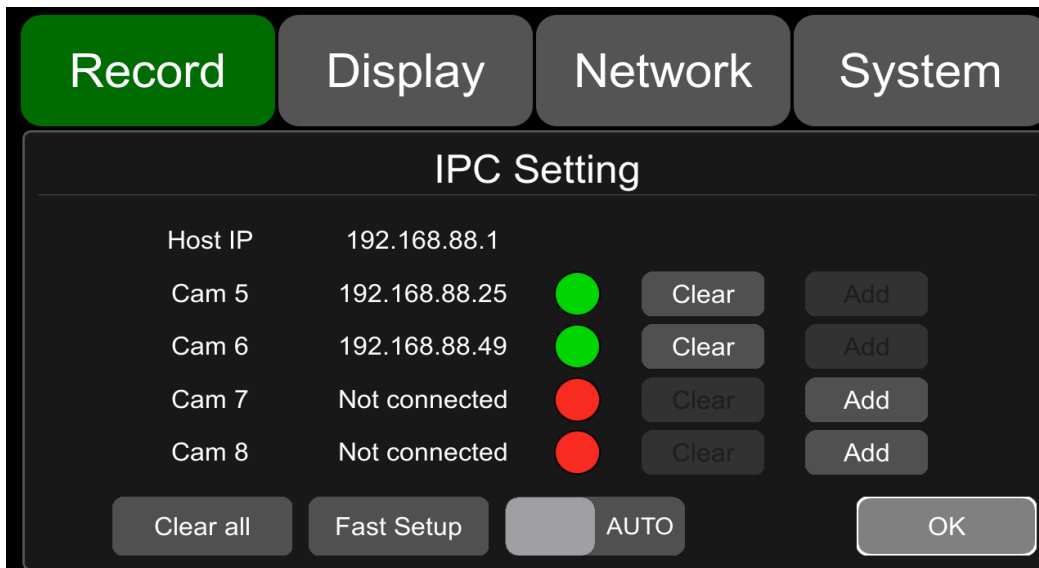
When AUTO is set to "On", Clear, Add, Clear All, and Fast Setup settings all cannot be operated.



 : Indicate that the IPC has been connected successfully.

 : Indicate that no IPC is connected.

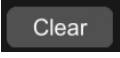
 Clear: Press the button, then the DVR will disconnect the IPC that has been successfully connected to the corresponding channel.

 Add: Button for entering the IPC-adding interface.

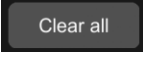

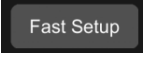

 Clear All: Press the button, then the DVR will disconnect all IPC channels that have been connected successfully.

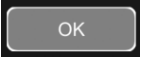
 Fast Setup: Press the button, then all IPCs are connected to the device quickly.

 AUTO: Automatically connect to the detected IPC. When AUTO is set to "On", Clear, Add, Clear All, and Fast Setup settings cannot be operated. AUTO is off by default.

 OK: Save the interface and exit.

 Add: IPC-adding interface.

Record		Display	Network	System
No.	IP	User Name	Password	Status
<input type="checkbox"/> 1.	192.168.70.127	<input type="text"/>	<input type="text"/>	
<input type="checkbox"/> 2.	192.168.88.233	<input type="text"/>	<input type="text"/>	
<input type="checkbox"/> 3.	192.168.70.175	<input type="text"/>	<input type="text"/>	
<input type="checkbox"/> 4.	192.168.88.192	<input type="text"/>	<input type="text"/>	
<input type="checkbox"/> Manual add	<input type="text"/>	<input type="text"/>	<input type="text"/>	

**IP:** Indicate the IP of the relevant IPC searched by the DVR.

**User Name:** IPC user name.

**Password:** IPC password.

**Status:** The connection status of the searched IPC; the relevant status is explained as follows:



: Indicate that the IP network segment of the IPC is inconsistent with that of the DVR, which means the network segment is incorrect.



: Indicate that the IPC is normal and can be connected to the DVR.



: Indicate that the IPC has been connected successfully.



: Indicate that the IP format of the IPC is malformed.

**Manual add:** If the IP connected to the IPC is not found, you can add the IPC by manually entering the IP, User Name and Password of the IPC. If the IPC does not have a user name and password, you only need to enter the IP of the IPC.

**Add:** IPC- adding button, after pressing the Add button, the IP of the selected IPC will show that the connection is successful.

**Filter:** If the filter is turned on, the screen will not display the IPC that the DVR has successfully connected to in this interface; when the filter is off, the screen displays all searched IPCs in this interface.

**Refresh:** If the IP connected to the IPC is not found in the interface shortly after booting, you can click this button to refresh the interface.

**OK:** Save the configuration and exit the interface.

**Cancel:** Do not save the configuration and exit the interface.

After the IPC connection is successful, you can view the IPC channel recording via the following interface.

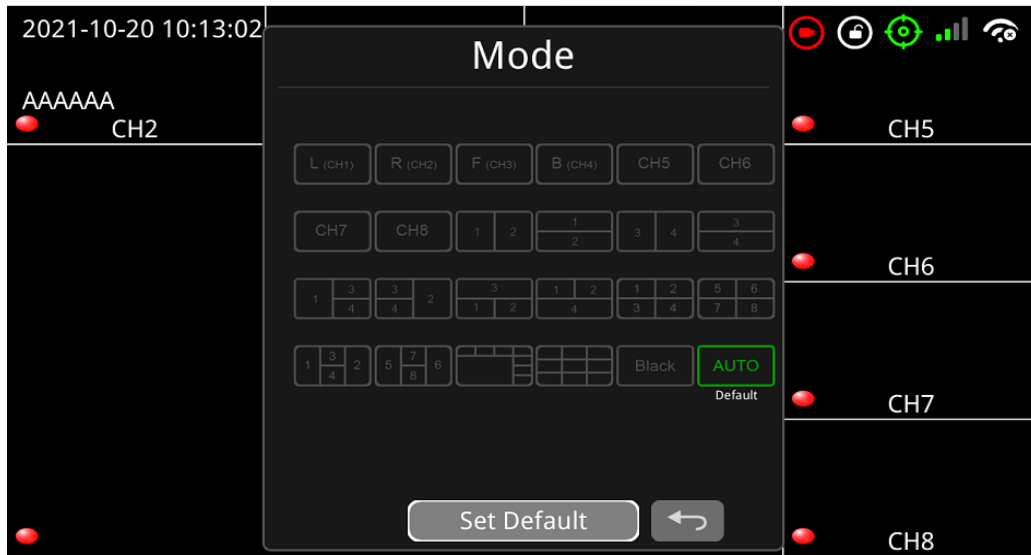

When IPC AUTO is the Default setting, the restarted DVR automatically switches to an eight-split display on the main and sub-screen after 1min of being connected to the IPC channel. If the IPC channel is not connected, the DVR automatically switches to a four-division display of CH1~CH4 after 1min; if you select other split modes other than AUTO as the Default setting, the DVR will display the chosen split mode upon restarting.

## 8.7 Event Duration



The default configuration is shown above.

When the “Event Rec” is set to ON, the video file length of event recordings can be set as 5s, 10s or 15s. The video file length will be maximally 5 minutes if an alarm is continuously triggered.

## 8.8 File Length



The default video file length in AVI and MSV format is 5 min.

AVI format video file length can be set to 5 minutes, 10 minutes, 15 minutes. The length of the video file in MSV format can be set to 2 minutes, 3 minutes, 5 minutes.

File Format	File Length
AVI	5min,10min,15min

## 8.9 Motion Sensitivity



The default configuration is shown above.

Motion detection recording and sensitivity level setting: When there is an object moving and its movement amplitude exceeds the preset motion detection sensitivity level, then motion detection recording will be triggered. For such kind of event recording, the pre-recording time is set as 10s and the post-recording time is set according to the configuration in Event Duration above.

Total video file length equals to the pre-recording file length (default time 10s) plus the file length configured in Event Duration.

If motion detection is set to OFF, event recording will not be triggered. Motion detection sensitivity can be set to two levels, low or high. Motion detection recording will be on when Low / High is selected. And it will be off when OFF is selected.

## 8.10 G-Force Sensitivity

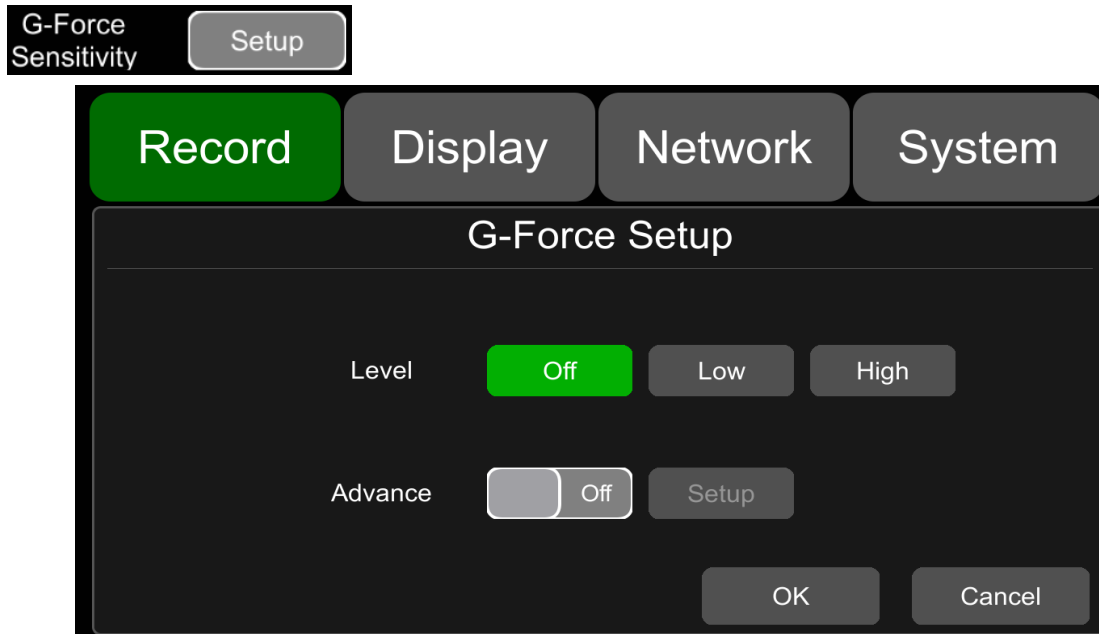

The default configuration is shown above.

There are two optional setting modes for G-force, simple mode and advanced mode. It only requires setting the trigger level of G-force if the simple mode is selected. Detailed instruction is as follow.

When the acceleration or gyroscope of the device reaches the preset sensitivity level, G-force recording will be triggered. For such kind of event recording, the pre-record time will be set as 10s and the post-recording time is set according to the configuration in Event Duration above.

Total video file length equals to pre-recording file length (default time 10s) plus the file length configured in Event Duration.

If G-force triggered recording is off, event recording will not be triggered. G-force sensitivity can be set to two levels, Low / High. G-force triggered recording will be on when Low / High is selected. And it will be off when OFF is selected.

If the advanced mode is set to ON, the simple mode will automatically be disabled. Detailed instruction is as follow.

- Principle of G-force Alarm Triggering Detection

The device will measure and detect the acceleration and angular velocity via a nine-axis G-force (transmitting data includes acceleration and angular velocity) when the vehicle moves on or makes a turn. When the acceleration and angular velocity exceeds a certain threshold within a certain period of time, the corresponding alarm will be triggered and recorded. Then the detected data will be uploaded to the cloud (Detection principle is shown in Pic 1.1). For example, according to the detected data, if the acceleration when the vehicle moves on or makes a turn exceeds the certain threshold acceleration “a” during the period “T” (default setting 100ms), then the vehicle’s speed of accelerating or making a turn will be identified as too fast, which is prone to cause traffic accidents.

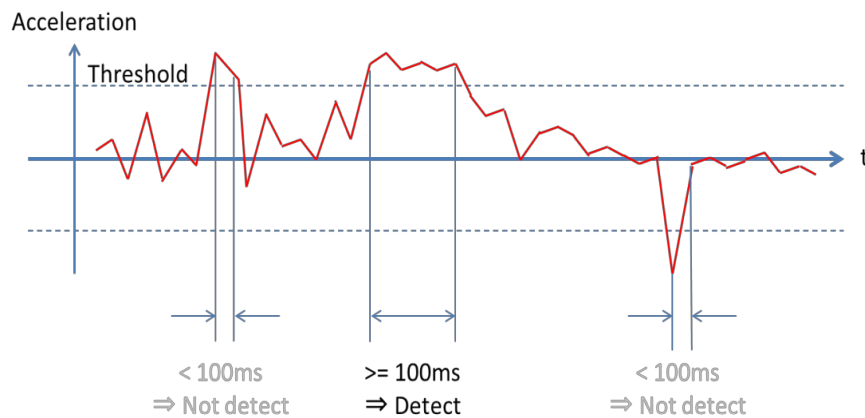

- Introduction to G-force Alarm Triggering Setting Interface

Enter the setting interface of the advanced mode of G-force under “Menu” -> “Record” -> “G-force Sensitivity” -> “Setup” -> “Advance” -> “ON”. The meanings of “Acce”, “Dece”, “Turn\_Acce”, “Turn\_Gyr”, “Impact” and “Filter” are as follow.

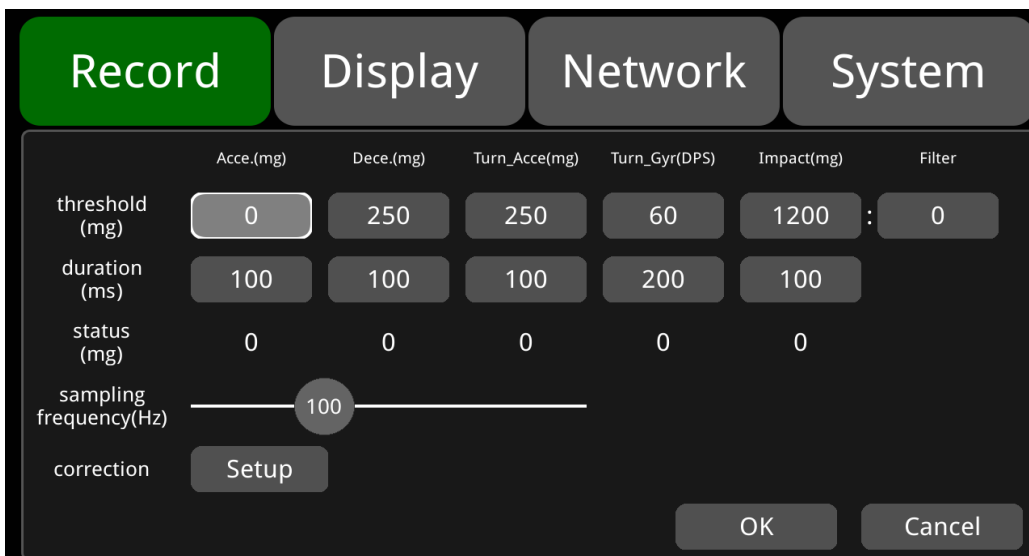

The meanings of “Acce”, “Dece”, “Turn\_Acce”, “Turn\_Gyr”, “Impact” and Filter”are as follow.

Items	Meanings
Acce.	The value of acceleration when the vehicle moves on (for detecting sudden acceleration)
	When the vehicle is accelerating, the value will be positive number. And when it is decelerating, the value will be zero.
	Unit: mg
Dece.	The value of deceleration when the vehicle moves on (for detecting sudden deceleration)
	When the vehicle is decelerating, the value will be positive number. And when it is accelerating, the value will be zero.
	Unit: mg
Turn_Acce	The value of acceleration when the vehicle makes a turn (for detecting sharp turn)
	When the vehicle is accelerating during left turn or decelerating during right turn, the value will be positive number. When the vehicle is decelerating during left turn or accelerating during right turn, the value will be negative number.
	Unit: mg
Turn_Gyr	Making turns and angular velocity of the vehicle (for detecting sharp turn and turning direction)
	When the vehicle turns left, the value will be positive number. When it turns right, the value will be negative number.
	DPS (Radian per Second)
Impact	Acceleration of vehicle collision (for detecting collision event)
	Positive number
	Unit: mg
Filter	Weight coefficient of acceleration on Z-axis of impact(collision)
	Positive number
	The calculation method and scale factor are shown in Table 1.3.



The meanings of “threshold”, “duration”, “status”, “correction” and “sampling frequency” are as follow.

Items	Meanings
threshold	Threshold setting for “Acce”, “Dece”, “Turn_Acce”, “Turn_Gyr”, “Impact” and “Filter”. When the detected value continuously exceeds threshold setting for “duration”, then the alarm recording will be triggered.
duration	Detection time setting for “Acce”, “Dece”, “Turn_Acce”, “Turn_Gyr”, “Impact” and “Filter”
status	Real-time detected value of the corresponding event
correction	Setting for device installation and G-force data correction
sampling frequency	Sampling frequency of the G-force

The threshold and detection duration of alarm triggering recording can be modified according to different application environment. The shorter the detection duration is set and the lower the threshold is set, the higher the sensitivity of alarm triggering will be. The unit of acceleration is mg. (1g≈9.8m/s<sup>2</sup>, 1g=1000mg). The unit of angular velocity is Radian per Second (DPS).

The default values and ranges of thresholds and duration for G-force alarm triggering detection are shown in the table below.

The formula of calculating the acceleration of impact (collision) event is as follow.

The acceleration of impact events is calculated as follows.

	Default Values	Ranges
Acceleration Threshold	0 mg	101~999
Deceleration Threshold	250 mg	101~999
Turn_AcceThreshold	250 mg	250~999
Turn_Gyr Threshold	60 DPS	21~99
Impact Threshold	1200mg	101~19999
Filter	0	0~5
Acceleration Duration	100ms	1~4999
Deceleration Duration	100ms	1~4999
Turn_Acce Duration	100ms	1~4999
Turn_Gyr Duration	200ms	1~4999
Impact Duration	100ms	1~4999

$abs(X) + abs(Y) + abs(Z) * Filter.$

“abs(X)”, “abs(Y)” and “abs(Z)” are the data from the X, Y and Z axes of acceleration sensors in the vehicle. Filter is the coefficient from the Z axis of acceleration sensor.

Filter rate of Z axis:

Sensitivity Level	Filter Rate
0	100%
1	80%
2	60%
3	40%
4	20%
5	0%

Acceleration Sensitivity level and value from Z axis for collision detection (Default level: 0) as shown above.

E.g.: Threshold: 1200 mg; Interval: 100ms

1) Setting value: 5

Detection condition:  $\text{abs}(X) + \text{abs}(Y) + \text{abs}(Z) \geq 1200\text{mg}$

2) Setting value: 4

Detection condition:  $\text{abs}(X) + \text{abs}(Y) + \text{abs}(Z) \times 0.8 \geq 1200\text{mg}$

3) Setting value: 3

Detection condition:  $\text{abs}(X) + \text{abs}(Y) + \text{abs}(Z) \times 0.6 \geq 1200\text{mg}$

4) Setting value: 2

Detection condition:  $\text{abs}(X) + \text{abs}(Y) + \text{abs}(Z) \times 0.4 \geq 1200\text{mg}$

5) Setting value: 1

Detection condition:  $\text{abs}(X) + \text{abs}(Y) + \text{abs}(Z) \times 0.2 \geq 1200\text{mg}$

6) Setting value: 0

Detection condition:  $\text{abs}(X) + \text{abs}(Y) \geq 1200\text{mg}$

The default values are detected as follow.

- 1) If the vehicle accelerates continuously in the positive direction of X axis and if the real-time value of Acce exceeds the threshold continuously for 100ms during driving, then the device will trigger an alarm of Acceleration.

- 2) If the vehicle decelerates continuously (brakes suddenly) in the positive direction of X axis and if the real-time value of Dece exceeds the threshold continuously for 100ms during driving, then the device will trigger an alarm of Deceleration.
- 3) If the vehicle quickly turns to the positive direction of Y axis and if the real-time value of Turn Acce exceeds the threshold continuously for 100ms during driving, then device will trigger an alarm of Turn Acce.
- 4) If the vehicle quickly turns to the opposite direction of Y axis and if the real-time value of Turn Acce exceeds the threshold continuously for 100ms during driving, then device will trigger an alarm of Turn Acce.
- 5) If the vehicle quickly turns to the positive or opposite direction of Y axis and if the real-time value of Turn Gyr exceeds the threshold continuously for 100ms during driving, then device will trigger an alarm of Turn Gyr.

- Introduction to Installation and Calibration of Device

There are various installation methods when the device is installed in the vehicle, because the device and the vehicle itself have different coordinate systems. The device coordinate system is shown in the picture below. The X axis refers to the front side of the device (the side with LED lights), the Y axis refers to the left side of the device (the side without lock). And the Z axis refers to the vertically upward direction when the device is installed.

**Z-axis** (in vertical upward direction)

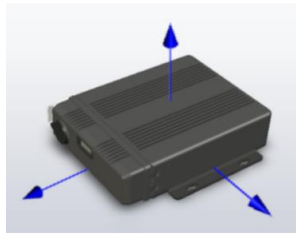

**X-axis** (the side with LED light)

**Y-axis** (the side without lock)

The vehicle coordinate system is shown in the picture below. In the coordinate system, the forward direction of vehicle is set as Forward axis and the left direction of vehicle is set as Left axis. There are multiple possible ways to install the device.

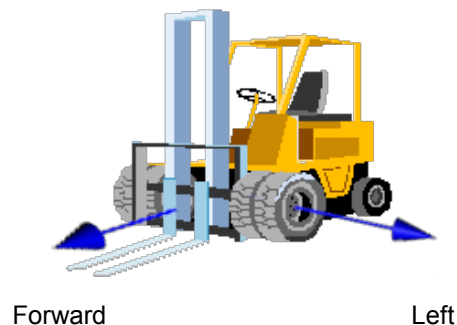

As shown below, there may be multiple installation positions for the device. In addition, there might be a slight tilt in the device installation process. So it requires calibration via the data from G-force.



- Device Installation Method Selection and Installation Correction

Forward and Left refer to the forward moving direction and the left moving direction of the vehicle. They help determine the directions of the vehicle with corresponding axes of the device, which is used to determine the installation method of the device.

Click the button “Forward” and “Left” to set the forward axis direction of the device relative to the vehicle. For example, if “Forward” is set to +X and “Left” is set to +Y, it means when the vehicle is moving forward, the forward direction of the device is the positive direction of the X-axis of the device. If “Forward” is set to -Z and “Left” is set to +Y, it means that when the vehicle is moving forward, the forward direction of the device is the opposite direction of the Z-axis and the positive Y-axis direction of the device is the left direction of the vehicle, that is to say, the device is vertically installed on the vehicle and its bottom is placed towards the front direction of the vehicle.

Installation Method Setting Interface as shown below.

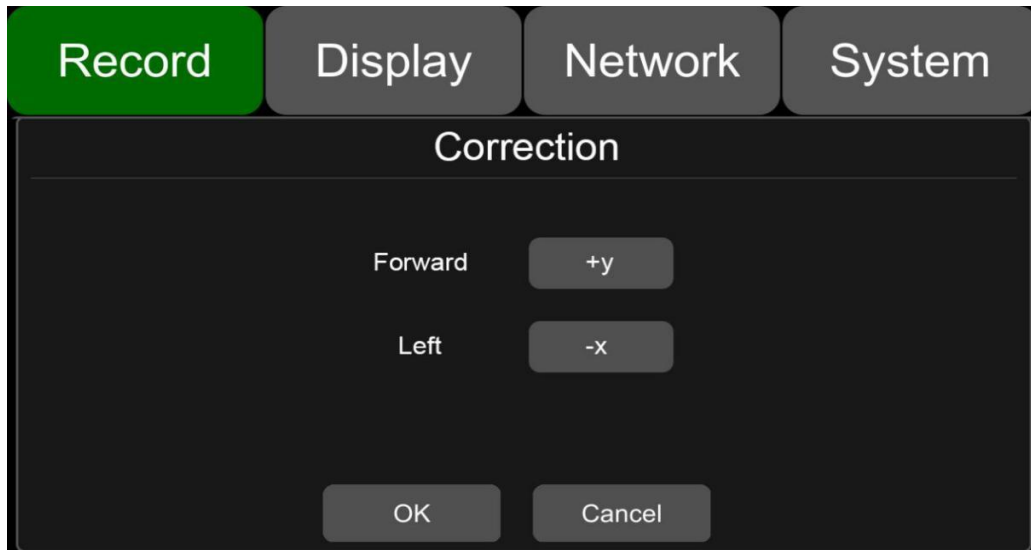

When the setting is finished, click the button OK to exit the interface. Please ensure that the vehicle stays still for more than 1s after the setting is finished, so that the system can apply the calibration

procedure. When the data of Status (real-time sensor data) is observed changed to close to 0, it means the calibration procedure is completed.

**WARNING:** The device installation must be calibrated before put into use. During the calibration process, the vehicle must be parked on a flat area in a static position and the calibration time shall not be less than 1s.  
When the device is installed for the first time or re-installed and when the installation position changes obviously, the installation position should be re-selected and re-

## 8.11 File Type



Set video format. Record video files in AVI format by default.

## 8.12 Record Audio



Set the recording audio of the channel. When the recording channel is selected, the audio of the channel will be recorded in the recording file. If this channel is not selected, there is no audio in the recording of this channel. The default configuration is shown below.

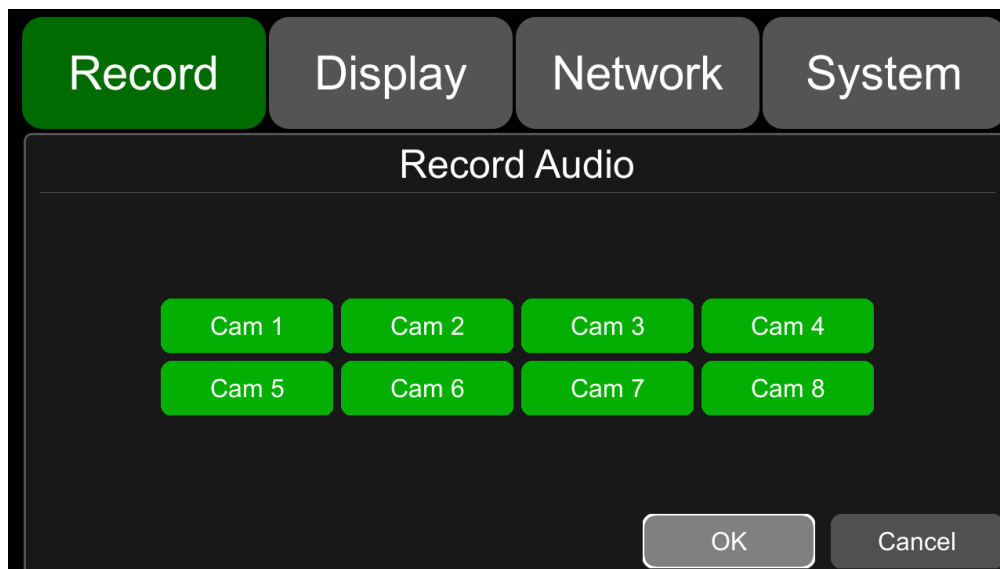

## 9 Display

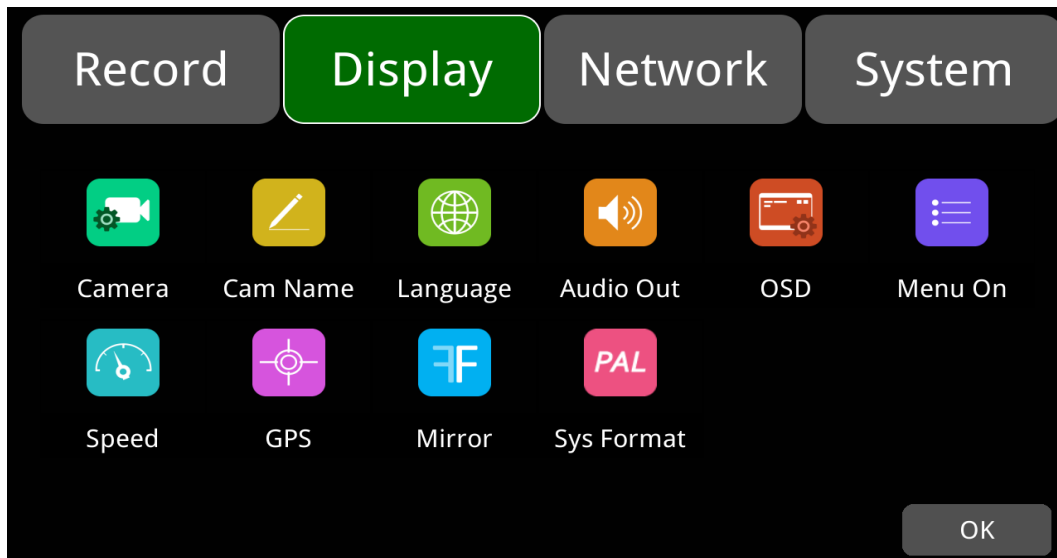

### 9.1 Camera Display Setting



Camera parameter setting for each corresponding channel includes brightness, contrast, saturation and hue. The default values of brightness, contrast, saturation and hue of all channels are shown in the figure below.

To change the value, drag the bar to left or right to decrease or increase.

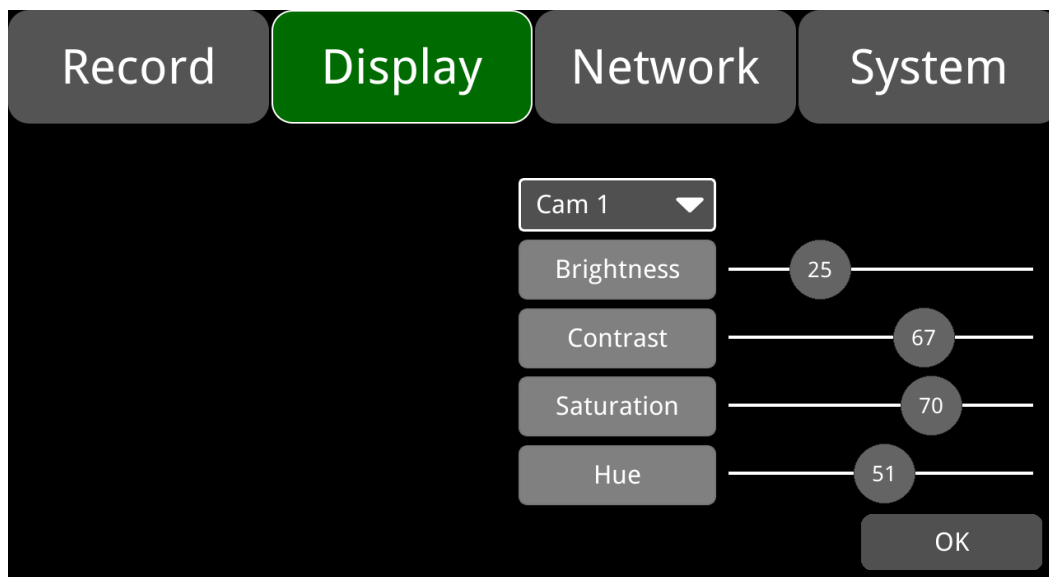

Camera Display	Min,	Max.	Default
Brightness	0	99	25
Contrast	0	99	67
Saturation	0	99	70
Hue	0	99	51

## 9.2 Camera Name Setting



Camera Names are displayed at the bottom of each channel. Touch the “Display->Camera Name->Cam\*” on the menu, a keyboard will pop up to input a new camera name. Maximum 8 characters can be entered and the camera name must NOT be blank. The default configuration is shown below.

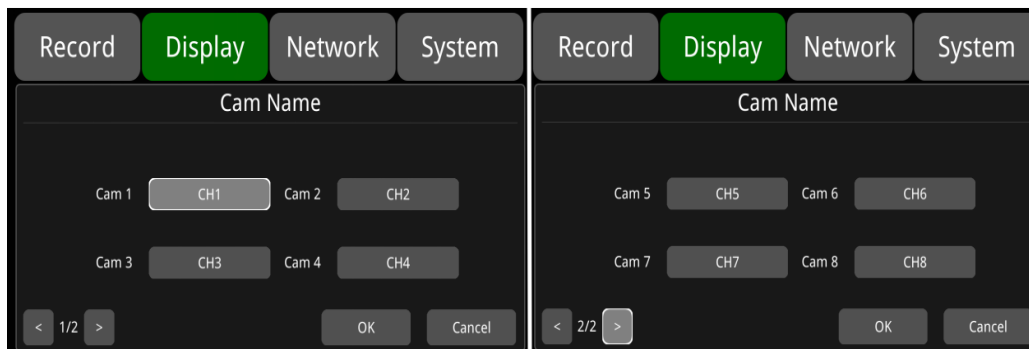

## 9.3 System Language Setting



Menu languages: English, Russian, Turkish, Chinese, Japanese, Spanish, Portuguese, French. The default language is English.

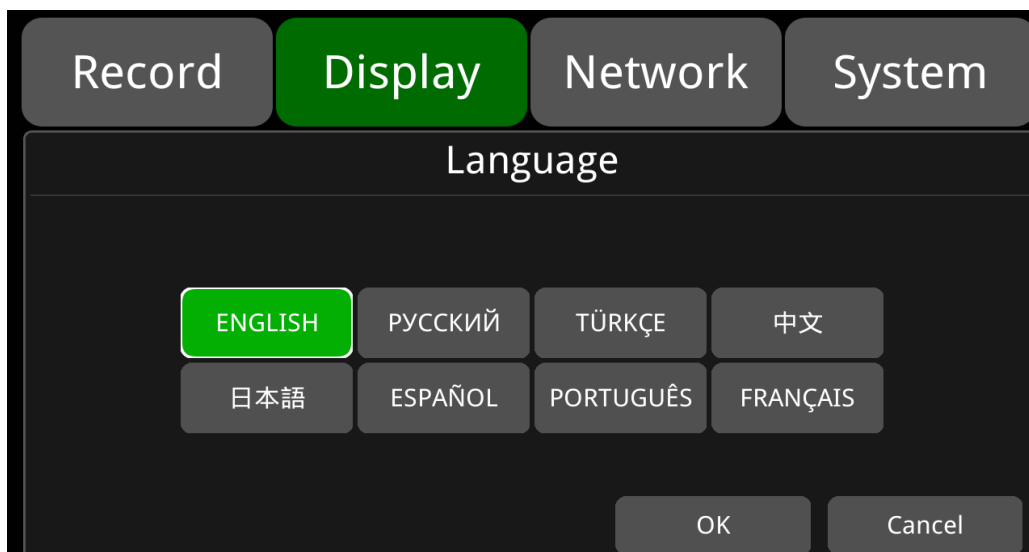

## 9.4 Audio Out



Select the audio output channel in multi-display mode. The default configuration is shown below.

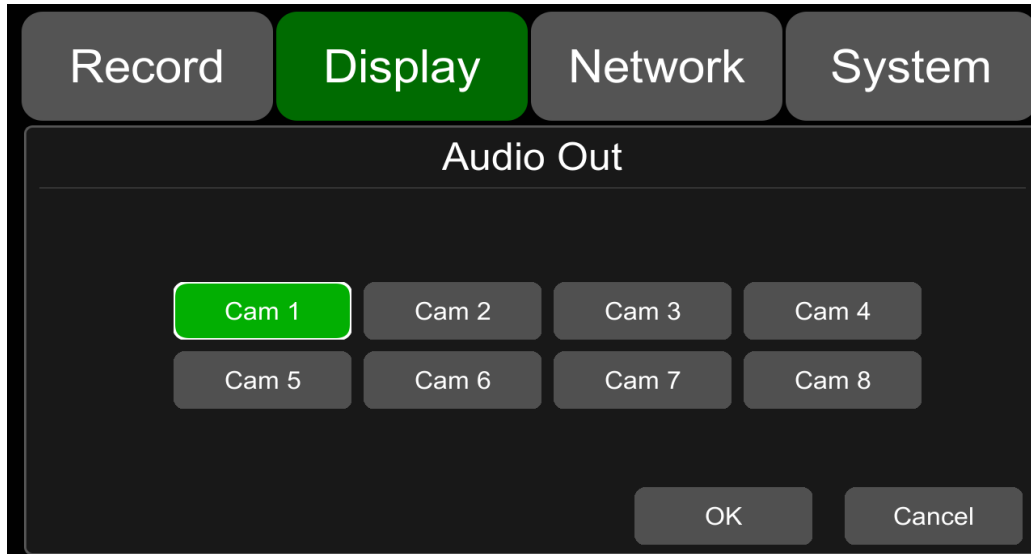

## 9.5 OSD Display Setting



Time, Camera name, License number and Speed can be selected whether to display or not. If it is on, the information will be shown in the live and the playback video. The default configuration is shown below.

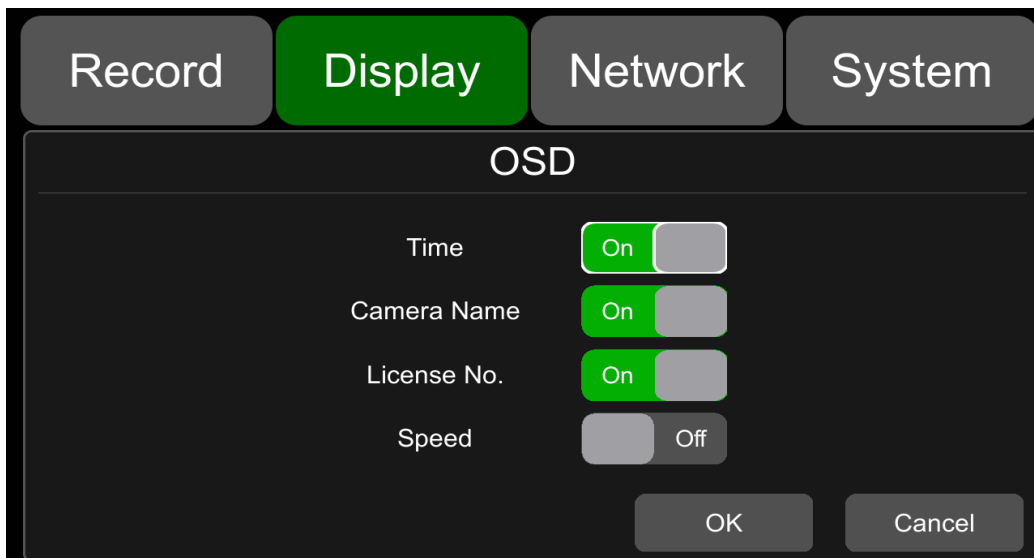



## 9.6 Menu on



Set the menu display duration. The default configuration is shown below.

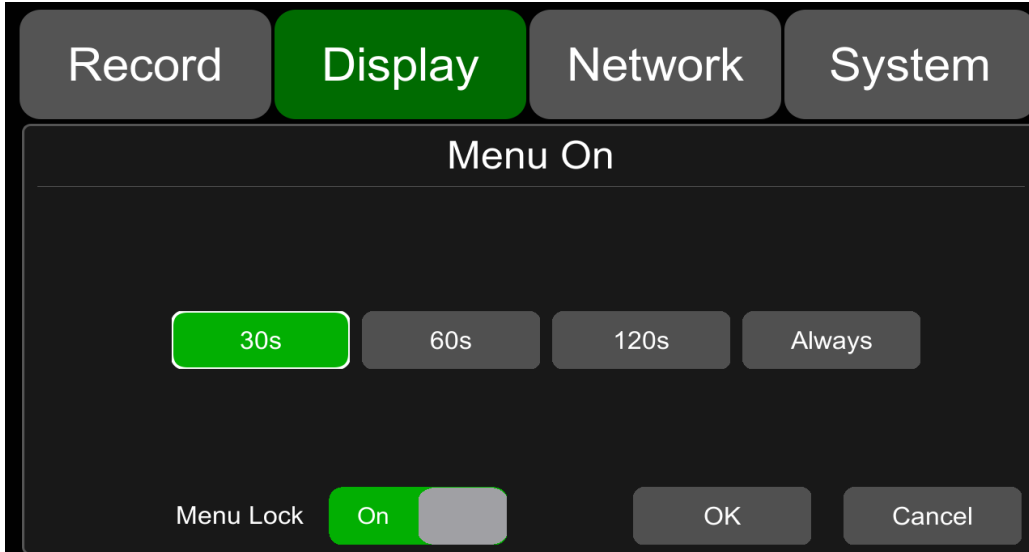

**Menu on:** Duration can be set to 30s, 60s, 120s and Always. When it is set to 30s, 60s, 120s, it means that the menu will disappear if there is no operation in 30s, 60s or 120s. When it is set to Always, the menu will always be there. Please be noted that the recording will stop when menu is on. It is not suggested to set the duration to Always in order not to affect the recording.

**Menu lock:** When it is On, permission is required to enter the menu.

When it is Off, no permission is required to enter the menu.

Username and password are required if to change the status of the menu lock.

## 9.7 Speed



Speed setting: The data source of overspeed comes from GPS. Speed unit is optional: Km/h or Mile/h. Overspeed threshold can be set by user. Speed refers to the current speed of the vehicle. If the Speed exceeds the value of the Overspeed, the overspeed alarm recording will be triggered.

The alarm switch is to set the over-speed alarm recording ON and OFF. If it is ON, the overspeed alarm recording will be triggered when the vehicle is speeding. If it is OFF, the overspeed alarm recording will not be triggered. The default configuration of each item is as follows.

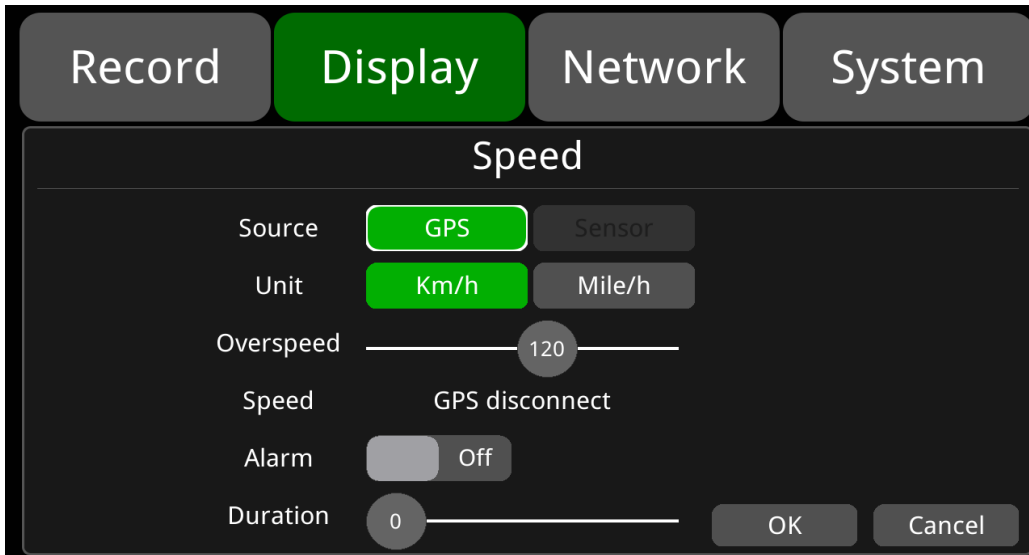

Overspeed	Min.	Max.	Default
Km/h	0	200	120
Mile/h	0	125	75

## 9.8 GPS



When the GPS antenna is properly installed, the latitude, longitude and speed will be recorded. The menu provides the GPS information including latitude, longitude, detectable satellites, and accessible satellites etc.

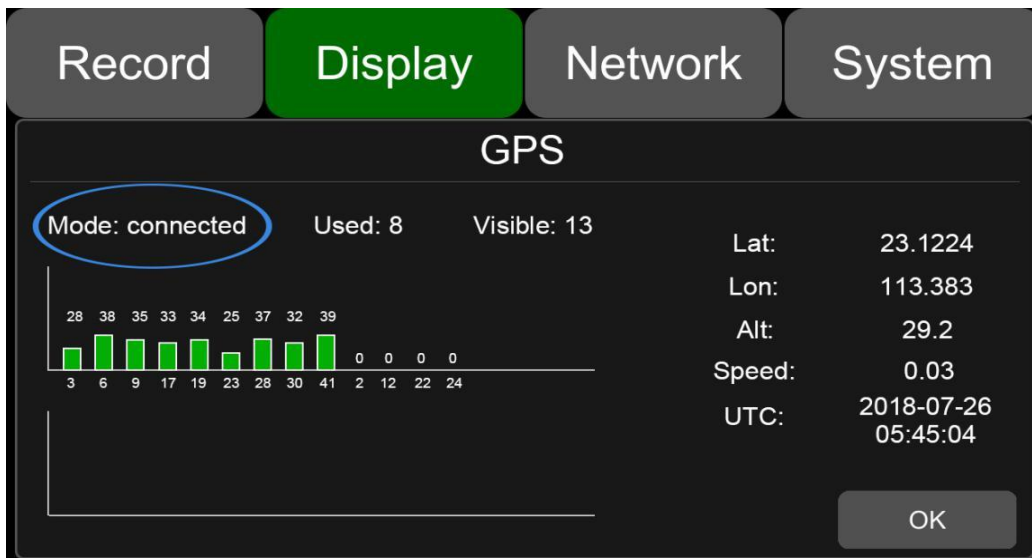

**Mode:** indicates the GPS connection status.

**Used:** indicates the number of available satellites.

**Visible:** indicates the number of searchable satellites.

## 9.9 Mirror



Horizontal and vertical flips of all channels are turned off by default.

**Horizontal:** when it is set to ON, the corresponding recording channel will flip horizontally; when it is set to OFF, no flip will be done.

The setting steps are show as follows.

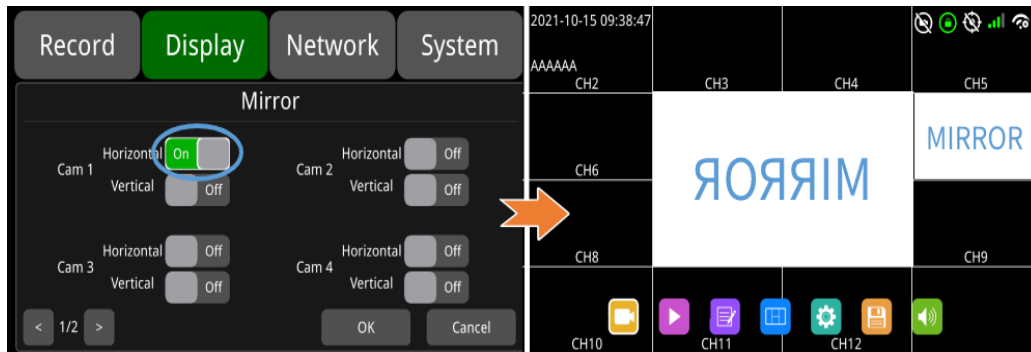
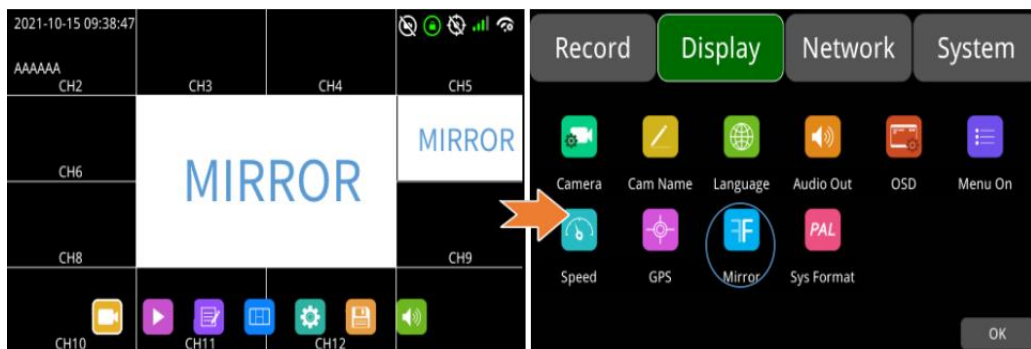

**Vertical:** when it is set to ON, the corresponding recording channel will flip vertically; when it is set to OFF, no vertical flip will be done.

The setting steps are show as follows.

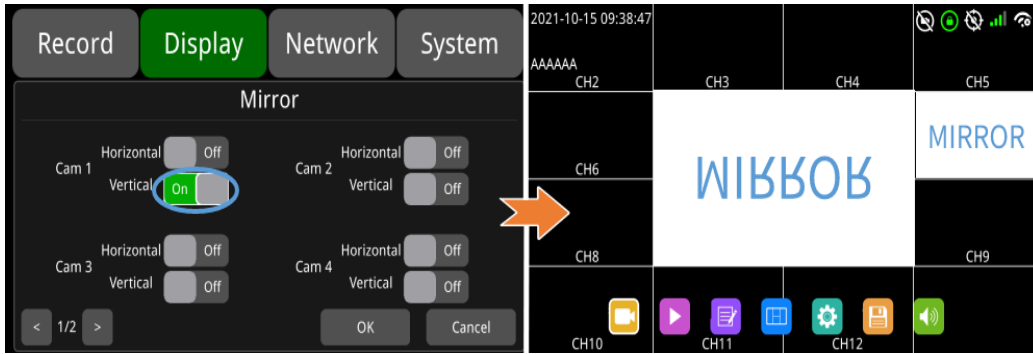

## 9.10 System Format Setting

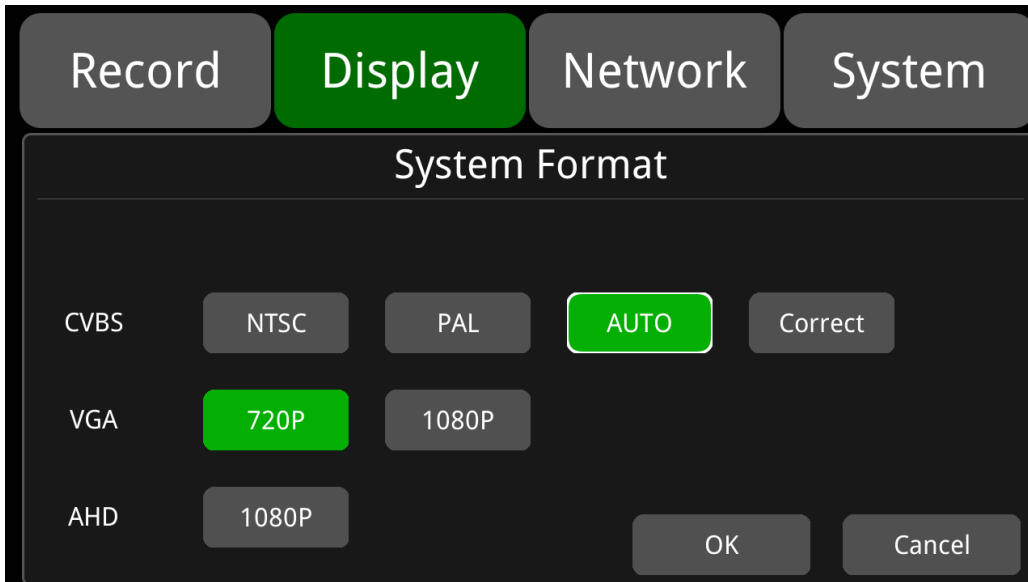

The default configuration is shown above.

**CVBS:** Standard definition display.

**VGA:** HD display.

**AHD:** HD display (Not available now).

Note: CVBS/VGA can be displayed together, AHD cannot be displayed together with CVBS/VGA, and only one of them can be displayed.

**Correct:** When the interface of the standard definition display on the screen is not fully displayed, the display interface can be reduced. Each unit of reduction is two pixels, and the maximum can be

reduced by 64 units. When the interface is reduced, the DVR can only be operated by the remote control.

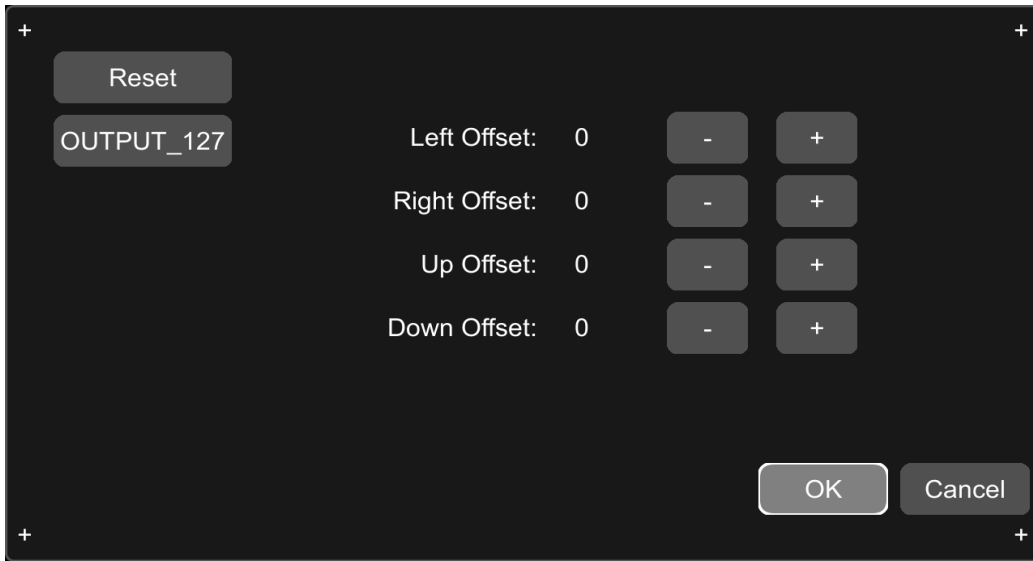

The default configuration is described in the following table.

OUTPUT_127	Left Offset	Right Offset	Up Offset	Down Offset
Default	30	28	12	10

Correct	Min.	Max.	Default
Left Offset	0	64	0
Right Offset	0	64	0
Up Offset	0	64	0
Down Offset	0	64	0

# 10 Network

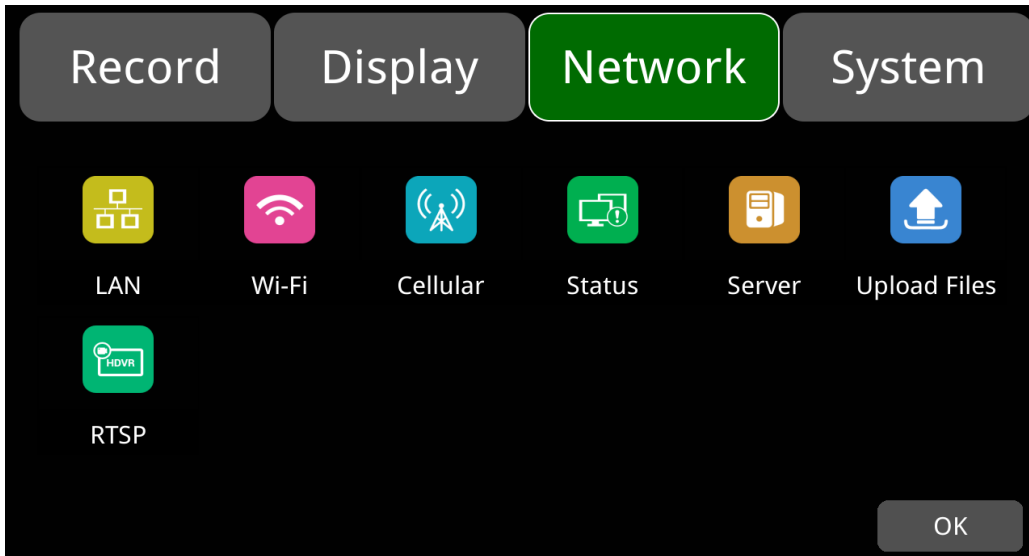

## 10.1 LAN and Server Setting

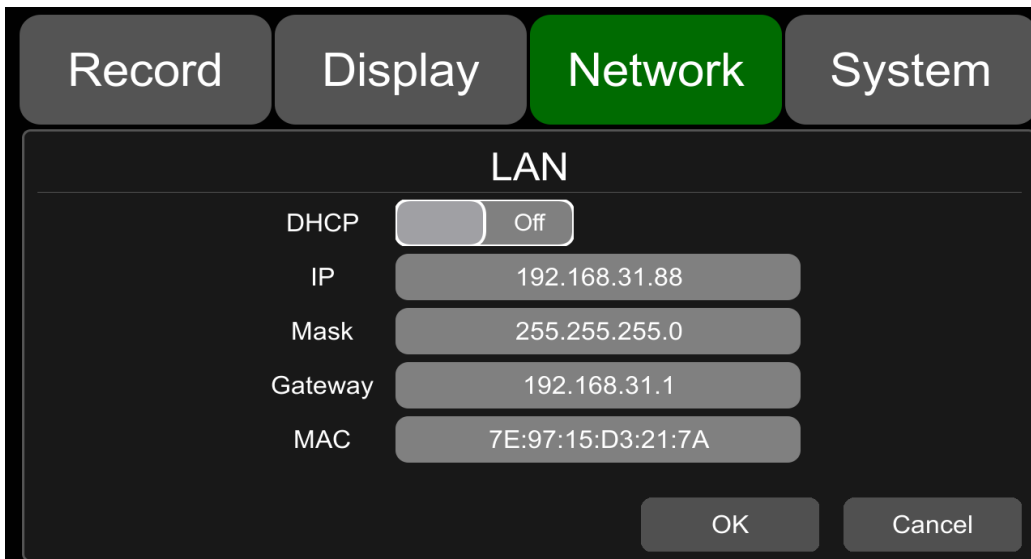

The default configuration is shown above.

- **DHCP:** Dynamic Host Configuration Protocol. Set On for dynamic IP and Off for static IP. Static IP must be manually input with IP address, mask and gateway. MAC address can be automatically assigned or revised.

- LAN connection

Step 1: Connect the LAN cable to the DVR.

Step 2: Go to “Network ->LAN” page.

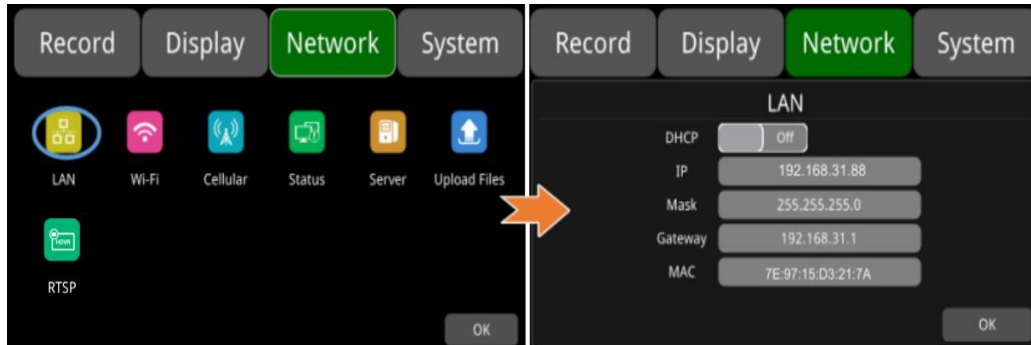

Step 3: If DHCP is set to ON, a dynamic IP will be automatically matched. If DHCP is set to Off, input the IP, mask, gateway and MAC manually.

Step 4: Touch OK to exit.

Step 5: Go to “Network - Server” page and touch the LAN icon.

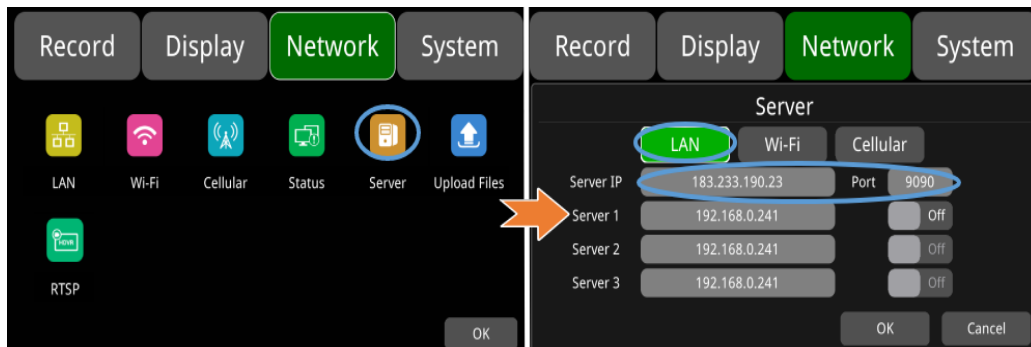

Step 6: Input LAN Server IP and Port. Touch OK to save the settings.

## 10.2 Wi-Fi Network Setup and Server Setup

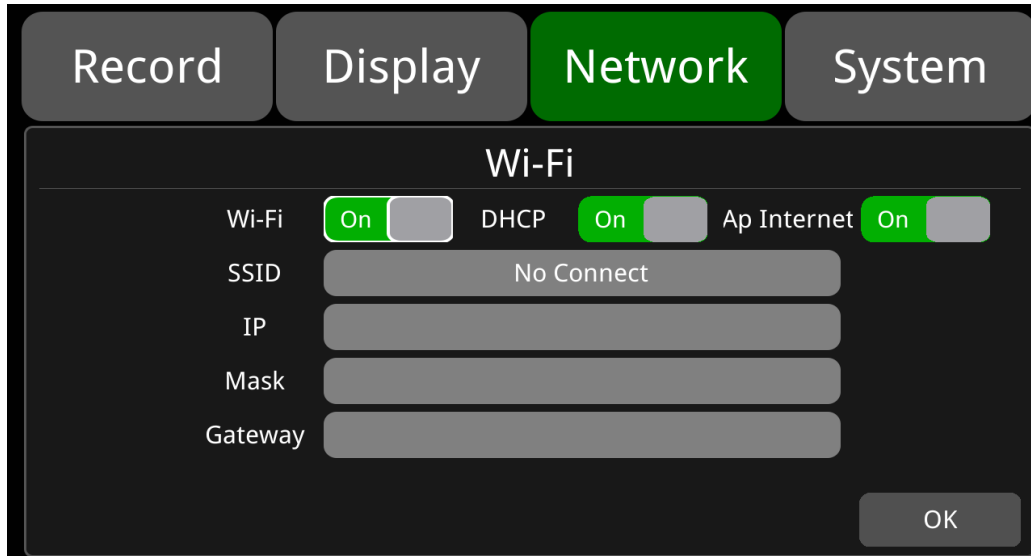

The default configuration is shown above.

Wi-Fi: ON/OFF

DHCP: Dynamic Host Configuration Protocol. Set On for dynamic IP and Off for static IP. Static IP must be manually input with IP address, mask and gateway.

SSID: Wi-Fi hotspot list.

AP Internet: The hotspot of the device can be found on mobile phones when it is On.

- Wi-Fi connection

Step 1: Make sure Wi-Fi hotspot is available.

Step 2: Connect the Wi-Fi antenna to connector ③ of the device rear panel.

Step 3: Go to Wi-Fi setup interface, set Wi-Fi to ON and DHCP to ON.

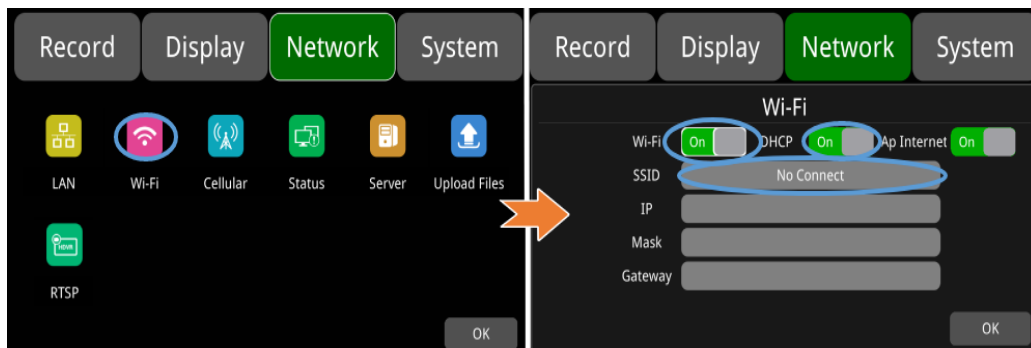



Step 4: Touch SSID sub-menu to select the hotspot and input the password.

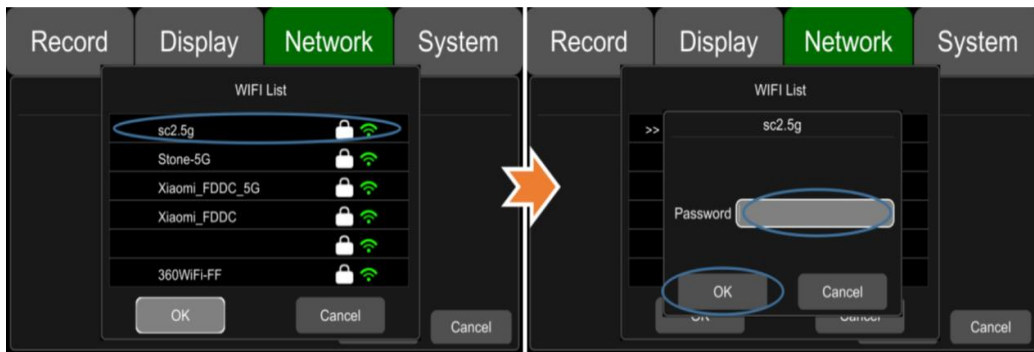

Step 5: Touch OK to exit.

Step 6: Go to "Network -> Server" page to input Wi-Fi Server IP and Port. Touch OK to save the settings.

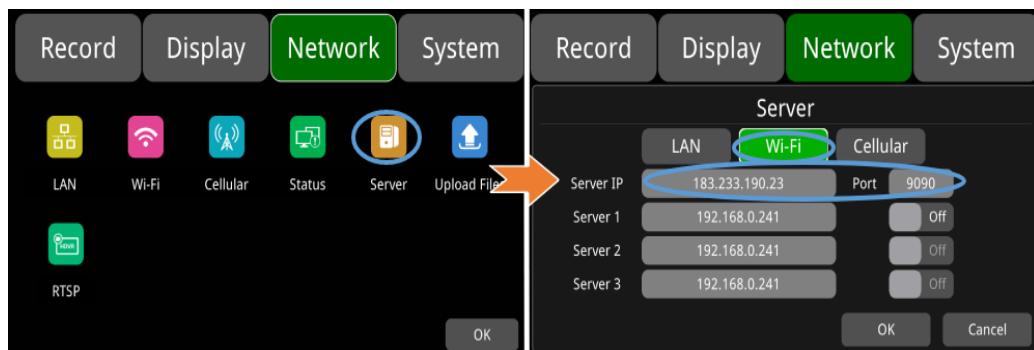

Step 7: Wi-Fi network status and server status can be checked on "Network ->Status".

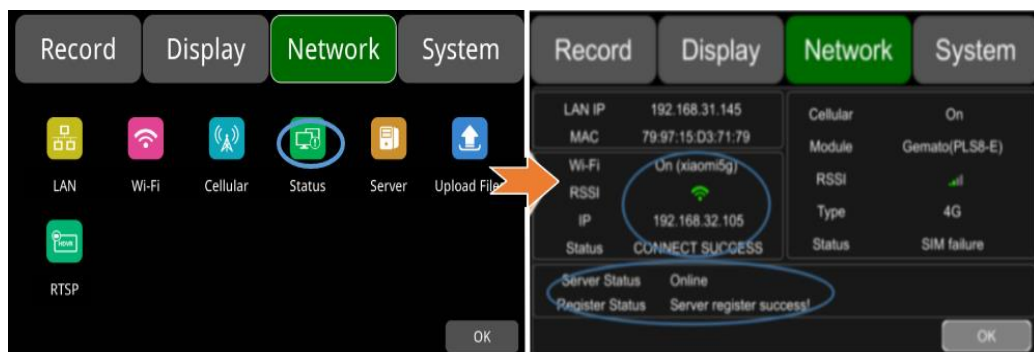

## 10.3 2G/3G/4G Control and Setup

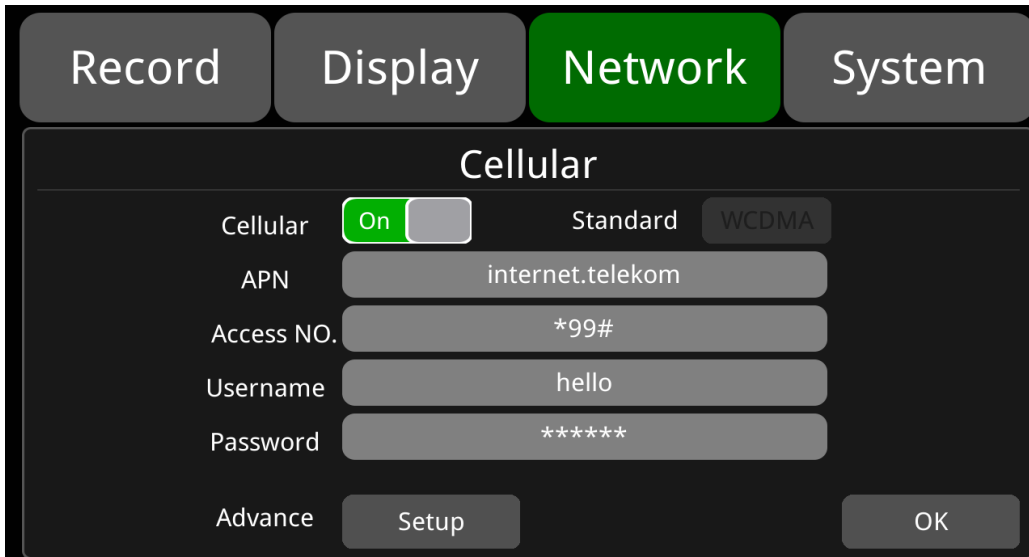

Record	Display	Network	System
<b>Cellular</b>			
Cellular	<input checked="" type="checkbox"/>	Standard	WCDMA
APN	internet.telekom		
Access NO.	*99#		
Username	hello		
Password	*****		
Advance	Setup	OK	

The default configuration is shown above.

**Cellular:** Cellular is on, meaning that 2G/3G/4G is on.

**APN & Access No.:** Normally, the user doesn't need to input user name and password for APN and Access number, the default setting is available. If connection is not successful under the default settings, please consult your local network carrier.

**OK:** Save the settings and exit.

**Cancel:** Cancel the settings and exit.

- 2G/3G/4G Connection

Step 1: DVR can search 2G/3G/4G signals locally.

Step 2: Connect the 2G/3G/4G antenna to connector ①&② of the device rear panel.



Step 3: Open the device front panel and insert the SIM card.

Step 4: Go to Cellular setup interface and set Cellular to ON.

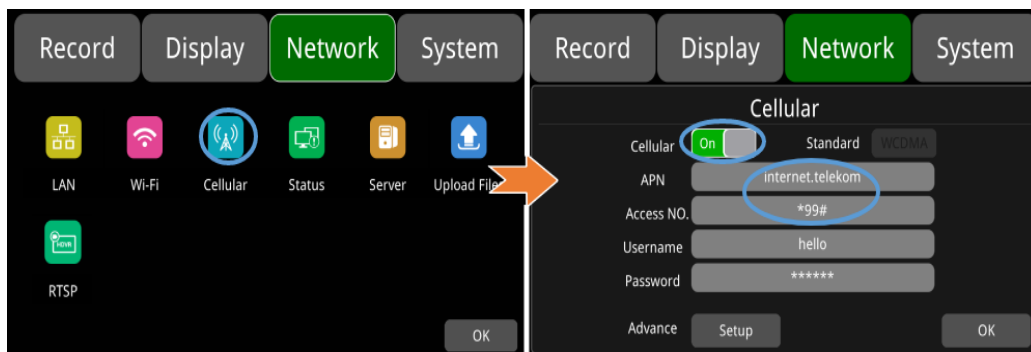

Step 5: Enter the correct APN.

Step 6: Touch OK to exit.

Step 7: Input the 2G/3G/4G Server IP and Port on "Network->Server".

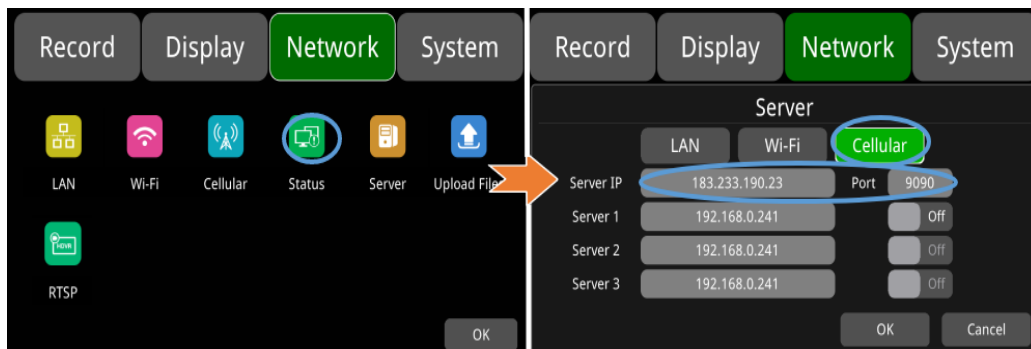

Step 8: Cellular network status and server status can be checked on "Network ->Status".

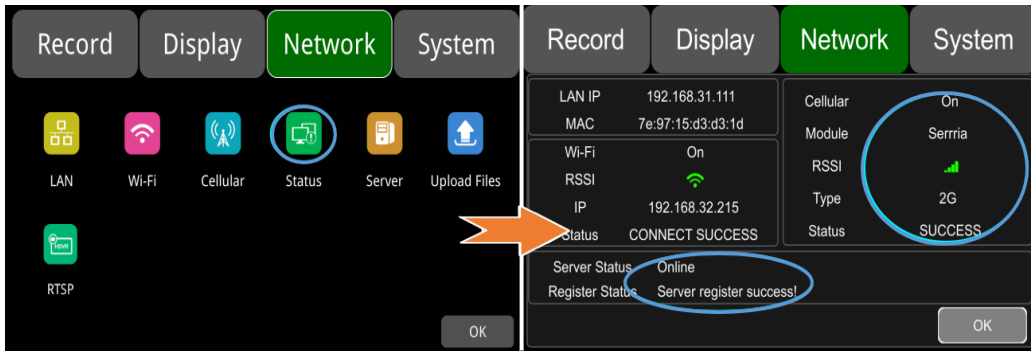

## 10.4 AP Internet Setup

- Steps To Connect AP Internet

Step 1: Connect the DVR to the internet through Wi-Fi or 2G/3G/4G. Please refer to Chapter 10.2 and 10.3 for connection.

Step 2: Set the “AP Internet” to ON.

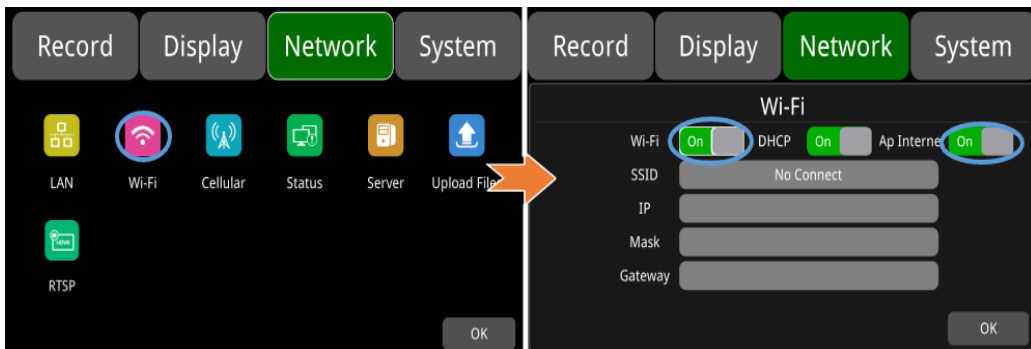

Step 3: Search and connect to the Wi-Fi hotspot of the DVR with other mobile devices. The SSID name of the hotspot is prefixed with “WFD-” and followed by the serial number of the device. “WFD-” default password is ap12345678.

## 10.5 Network Status



Network Status: LAN IP address, MAC address, Wi-Fi network status, Wi-Fi IP address, Wi-Fi signal strength, cellular network status, cellular signal strength and server status etc. can be checked.

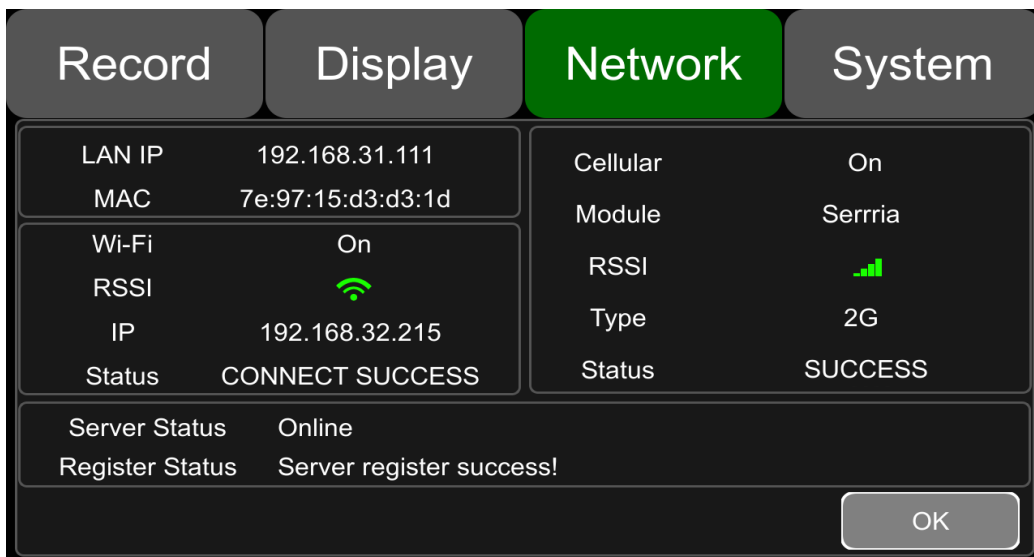

**LAN IP:** The static IP set on “Network->LAN” page or the dynamic IP obtained automatically.

**MAC:** The static physical address set on Network-LAN page or the dynamic physical address obtained automatically.

**Wi-Fi:** Status indication.

**Wi-Fi RSSI:** Wi-Fi signal strength indication.

**Wi-Fi IP:** Static IP obtained from Network-Wi-Fi page or dynamic IP address.

**Wi-Fi status:** CONNECT SUCCESS or GET IP ERROR.

**Cellular:** Status indication.

**Module:** The Cellular module brand.

**Cellular RSSI:** 2G/3G/4G signal strength indication.

**Cellular Type:** 2G, 3G or 4G, indicating the actual signal received.

**Cellular Status:** please refer to the descriptions and indications below.

Description	Indication
Module initialization	Cellular module is initializing.
Module exception	Cellular module is in exception.
No SIM card	No SIM card is found in the DVR.
Cpin locked	Cpin is locked.
Signal abnormal	Signal is abnormal.
Networking failure	Network connection is failed.
SUCCESS	Network connection is successful.

**Server Status:** Online / Offline.

**Register status:** Reasons for failed server connection.

## 10.6 Server



The function of server setting is mentioned in Chapter 10.1, 10.2 and 10.3. LAN, the default server IP of LAN, Wi-Fi and Cellular are “183.233.190.23”, and the default port number is “9090”.

The screenshot shows the 'Server' configuration screen. At the top, there are four tabs: 'Record', 'Display', 'Network' (highlighted in green), and 'System'. Below the tabs, the title 'Server' is centered. Underneath, there are three sub-tabs: 'LAN' (highlighted in green), 'Wi-Fi', and 'Cellular'. The 'LAN' section contains the following fields:

Field	Value
Server IP	183.233.190.23
Port	9090
Server 1	192.168.0.241
Server 2	192.168.0.241
Server 3	192.168.0.241

On the right side of the 'LAN' section, there are three toggle switches, all set to 'Off', corresponding to the 'Wi-Fi' and 'Cellular' sub-tabs. At the bottom right, there are 'OK' and 'Cancel' buttons.

## 10.7 File Upload



The screenshot shows the 'Upload Files' configuration screen. At the top, there are four tabs: 'Record', 'Display', 'Network' (highlighted in green), and 'System'. Below the tabs, the title 'Upload Files' is centered. The screen contains the following settings:

- 'Upload Files' toggle switch: Off
- 'Normal Files' toggle switch: Off
- 'Celluar' toggle switch: Off
- 'Status' label: (no value shown)
- 'Uploading' progress bar: 0%
- 'Filename' label: (no value shown)

At the bottom right, there are 'OK' and 'Cancel' buttons.

“Upload Files” default configuration as shown above.

**Upload Files:** ON/OFF, when set to ON, as long as DVR triggers the alarm video file, the alarm video file will be uploaded to the server. When the value is set to OFF, DVR triggers the alarm video file and does not upload the alarm video file to the server.

**Normal File:** Two states, “OFF” and “ON”.

- OFF: Do not upload normal video files.
- ON: Upload normal video files.

**Cellular:** Two states, “OFF” and “ON”, When it is set to ON, as long as DVR triggers the alarm recording file and 2G/3G/4G is online, it will upload the alarm recording file to the server.

- OFF: When using Cellular to connect to the server, it is not allowed to upload normal video files. For example, the setting in the figure below means that normal video files will only be uploaded when the server is connected to LAN or Wi-Fi. When Cellular is connected to the server, normal video files will not be uploaded.

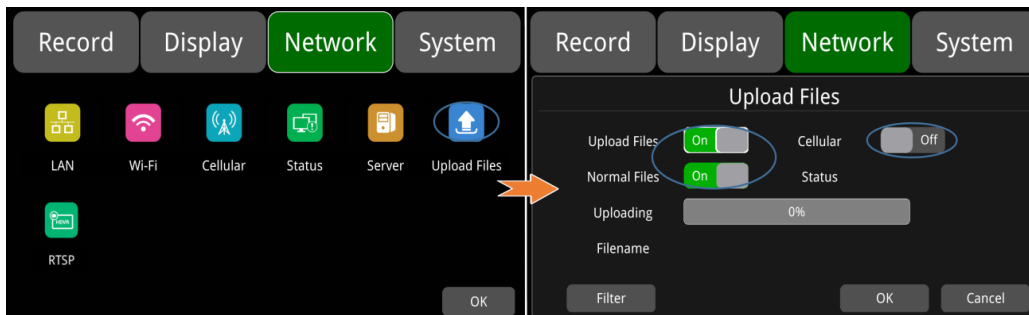

- ON: When using Cellular to connect to the server, uploading files is allowed. When the switch is turned on, a pop-up box will prompt "Network flow consuming, continue?" Click “OK” to confirm the opening, but after this feature is turned on, once Cellular connects to the server, it will upload the video file, which will consume a lot of cellular flow. So in order to save cellular flow, please set to “OFF”.

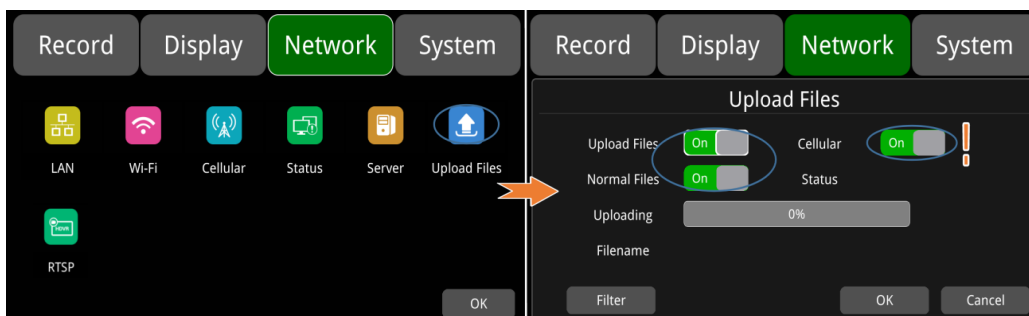

**Uploading:** Show progress bar of uploaded video file.

**Filename:** Display the file name of the uploaded video file.

**Status:** Display the working status of FTP. Successfully uploaded video files can be found in the client interface below.

Plate No	Begin Time	End Time	Status	Percent	Download	File Size	File Type	File Name	File Posit...
cz-426-00...	2020-11-0...	2020-11-0...	Not Downl...	0%	0		snap cam...	20201101180942_*_03.jpg	Media Ser...
cz-426-00...	2020-11-0...	2020-11-0...	Not Downl...	0%	0		snap cam...	20201101180942_*_01.jpg	Media Ser...
cz-426-00...	2020-11-0...	2020-11-0...	Not Downl...	0%	0		snap cam...	20201101180942_*_04.jpg	Media Ser...
cz-426-00...	2020-11-0...	2020-11-0...	Not Downl...	0%	0		snap cam...	20201101180942_*_02.jpg	Media Ser...
cz-426-00...	2020-11-0...	2020-11-0...	Not Downl...	0%	3		gsensor	20201102084315_*_03.m...	Media Ser...
cz-426-00...	2020-11-0...	2020-11-0...	Not Downl...	0%	3		gsensor	20201102084315_*_04.m...	Media Ser...
cz-426-00...	2020-11-0...	2020-11-0...	Not Downl...	0%	3		gsensor	20201102084315_*_02.m...	Media Ser...
cz-426-00...	2020-11-0...	2020-11-0...	Not Downl...	0%	3		gsensor	20201102084402_*_02.m...	Media Ser...
cz-426-00...	2020-11-0...	2020-11-0...	Not Downl...	0%	3		gsensor	20201102084402_*_04.m...	Media Ser...
cz-426-00...	2020-11-0...	2020-11-0...	Not Downl...	0%	3		gsensor	20201102084402_*_03.m...	Media Ser...
cz-426-00...	2020-11-0...	2020-11-0...	Not Downl...	0%	3		gsensor	20201102132958_*_04.m...	Media Ser...
cz-426-00...	2020-11-0...	2020-11-0...	Not Downl...	0%	3		gsensor	20201102132958_*_03.m...	Media Ser...
cz-426-00...	2020-11-0...	2020-11-0...	Not Downl...	0%	3		gsensor	20201102132958_*_02.m...	Media Ser...
cz-426-00...	2020-11-0...	2020-11-0...	Not Downl...	0%	3		gsensor	20201102133833_*_04.m...	Media Ser...
cz-426-00...	2020-11-0...	2020-11-0...	Not Downl...	0%	3		gsensor	20201102133833_*_02.m...	Media Ser...
cz-426-00...	2020-11-0...	2020-11-0...	Not Downl...	0%	3		gsensor	20201102133833_*_03.m...	Media Ser...

**Filter:** Alarm video type and upload channel selection, the default configuration is as follows.

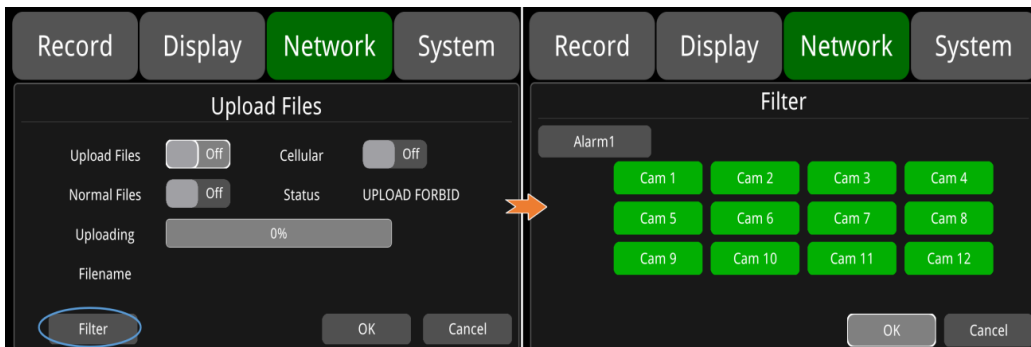

Click the Alarm1 to select different alarm type settings, as shown below.

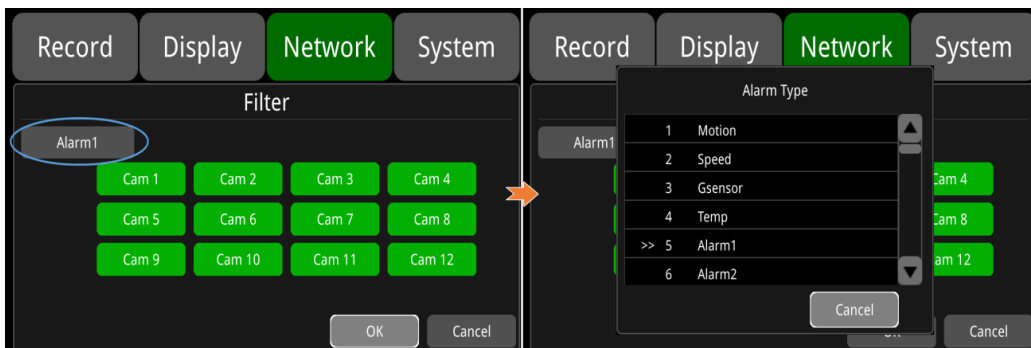

Alarm filter type:



Motion	Motion detection alarm	Speed	Overspeed alarm (velocity source: GPS)
Gsensor	G- Force alarm	Temp	Temperature alarm
Alarm1	Alarm 1 alarm	Alarm2	Alarm 2 alarm
Alarm3	Alarm 3 alarm	Alarm4	Alarm 4 alarm
Alarm5	Reverse alarm	Alarm6	Brake alarm
Alarm7	Alarm 7 alarm	Alarm8	Alarm 8 alarm
Button	Panic button alarm	Rfid	Rfid abnormality alarm
AccLe	Acceleration alarm	DeceLe	Deceleration alarm
AccTurn	Turning acceleration alarm	GyrTurn	Turning angular velocity alarm
Impact	Collision alarm	GyrTurnLeft	Turn left alarm
GyrTurnRight	Turn right alarm	GyrClipFile	Active clip alarm
Button1	Panic button 1 alarm	Button2	Panic button 2 alarm
Button3	Panic button 3 alarm	Button4	Panic button 4 alarm
Button5	Panic button 5 alarm	Button6	Panic button 6 alarm
Button7	Panic button 7 alarm	Button8	Panic button 8 alarm
Fatigue	Fatigue alarm	Distraction	Distraction alarm
NoDriver	No driver alarm	Smoking	Smoking alarm
Calling	Calling alarm	PasserBy	Pedestrian detection warning
Crash	Forward collision warning	Skewing	Lane departure warning
OverSpeed	Overspeed alarm (velocity source: ADAS)	Snapacm	Screenshot alarm
Radar	Radar alarm	Rfid ERR	Abnormal swiping alarm
Rfid Sameid	Abnormal card number alarm	Rfid Sum	Inconsistent passenger number alarm
Rm mem	Card off alarm	Yawn	Yawn alarm
FaceFail	Face recongniton failure alarm	No Mask	No mask alarm
Fatigue2	Second-time fatigue alarm	Over Temp	High temperature alarm
Less Temp	Low temperature alarm	OverReco Temp	High temperature recovery alarm
LessReco Temp	Low temperature recovery alarm	OpenDoor	Open door alarm
CloseDoor	Close door alarm	SABOTAGE	Sabotage alarm
BsdPasserby1	Channel 1 pedestrian detection alarm	BsdPasserby2	Channel 2 pedestrian detection alarm
BsdPasserby3	Channel 3 pedestrian detection alarm	BsdPasserby4	Channel 4 pedestrian detection alarm

## 10.8 RTSP Streaming

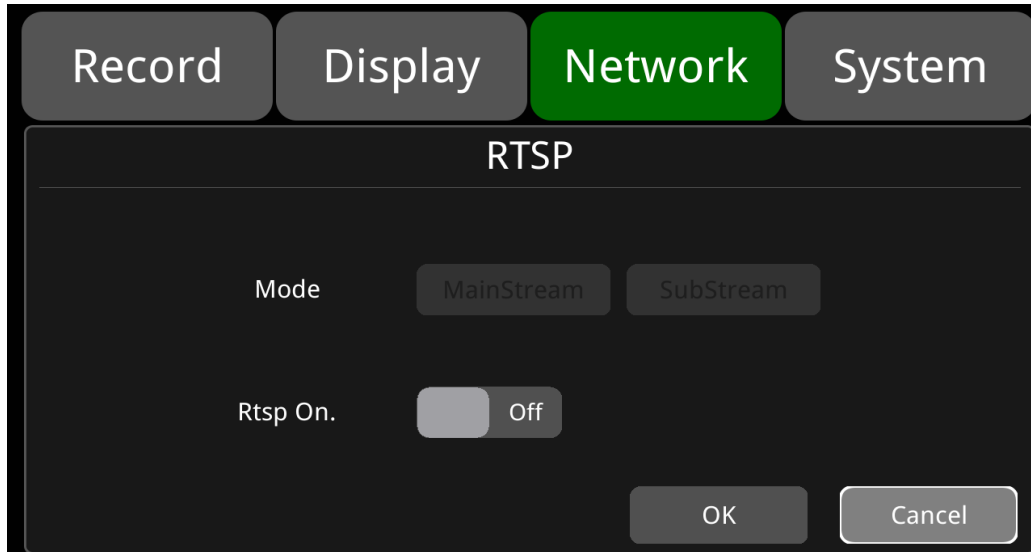

The default configuration is shown above.

- **RTSP On:** Set RTSP on /off
- **Mode:** Set MainStream & SubStream on/off.
- **mode on/off Instructions:** Set RTSP On, make sure the streaming device and DVR are under the same local area network, images can be displayed by using DVR's own hotspot AP. Or turn on RTSP On, connect the DVR and the device to the same route (Note: 192.168.100.140 is the fixed IP address of DVR's AP hotspot), open the network stream of the pull-streaming device, enter the streaming address under the network URL, 4 main-streams + 4 sub-streams, a total of 8 push-streams the formats are as follows:

Main-stream: rtsp://Ip Address/cam1/mainstream

Sub-stream: rtsp://Ip Addr/cam1/substream

# 11 System

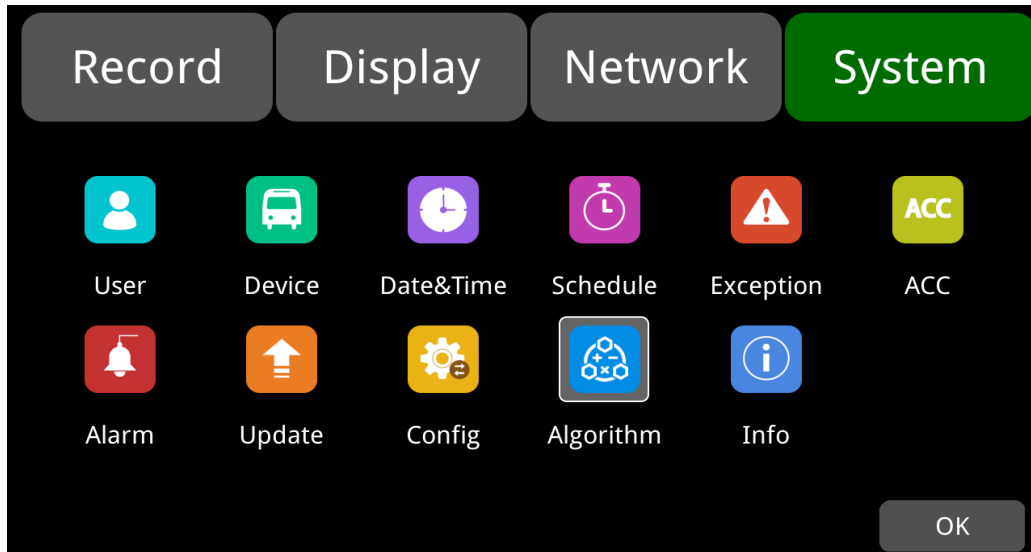

## 11.1 Log in Setup



Set user name and password for booting up. The initial password is 123.

A screenshot of a 'User' login setup form. The form has a title 'User' and four input fields: Username (with 'admin' entered), Password, New Password, and Confirm Password. There are OK and Cancel buttons at the bottom right.

User	
Username	<input type="text" value="admin"/>
Password	<input type="password"/>
New Password	<input type="password"/>
Confirm Password	<input type="password"/>

OK Cancel

## 11.2 License Plate Number Setup



Input license plate number. The default configuration is shown below.

Record	Display	Network	System
<b>Device</b>			
License No.	<input type="text" value="AAAAAA"/>		
Device ID	<input type="text" value="1711280010"/>		
			<input type="button" value="OK"/> <input type="button" value="Cancel"/>

## 11.3 System Time Setup



Format Setup: System time format setting

Record	Display	Network	System			
<b>Dates&amp;Time</b>						
Date	Year	Month	Day			
	<input type="text" value="2018"/>	<input type="text" value="06"/>	<input type="text" value="21"/>	<input type="button" value="1"/>	<input type="button" value="2"/>	<input type="button" value="3"/>
Time	Hour	Minute	Second			
	<input type="text" value="11"/>	<input type="text" value="17"/>	<input type="text" value="38"/>	<input type="button" value="4"/>	<input type="button" value="5"/>	<input type="button" value="6"/>
Format	<input type="button" value="Setup"/>	Time Sync	<input type="button" value="Setup"/>	<input type="button" value="7"/>	<input type="button" value="8"/>	<input type="button" value="9"/>
DST	<input type="button" value="Setup"/>			<input type="button" value="0"/>	<input type="button" value="Del"/>	
			<input type="button" value="OK"/> <input type="button" value="Cancel"/>			

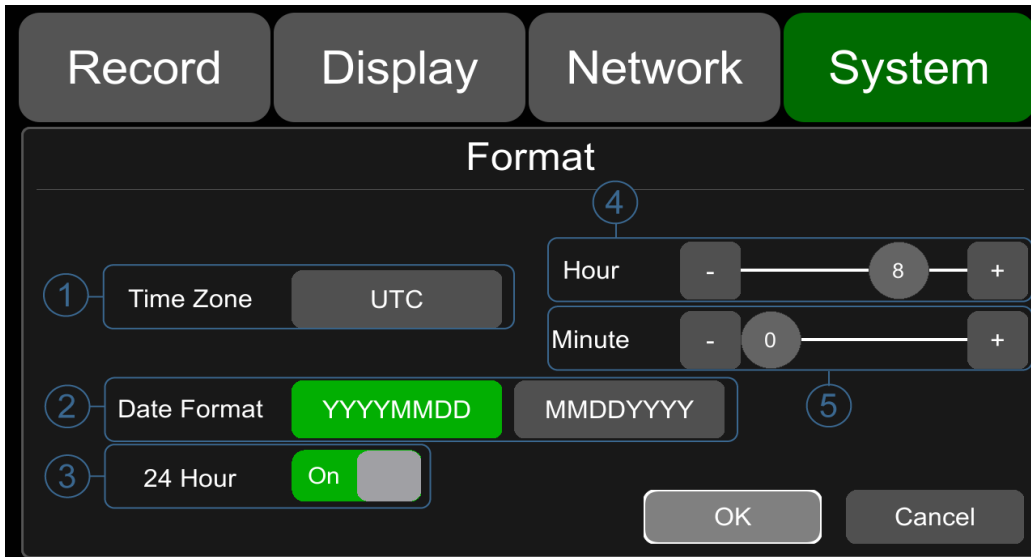

"Format" default configuration as shown above.

Go to "System ->Date &Time ->Format->Setup" page.

- ① Time Zone: Time zone setting.
- ② Date Format: Set the date of format.
- ③ 24 Hour: If it is ON, time format will be displayed in 24-hour system. If OFF, time format will be displayed in 12-hour system.
- ④ & ⑤ Hour & Minute: Time zone setting accurate to minute.

Hour & Minute	Min.	Max.	Default
Hour	-12	14	8
Minute	0	59	0

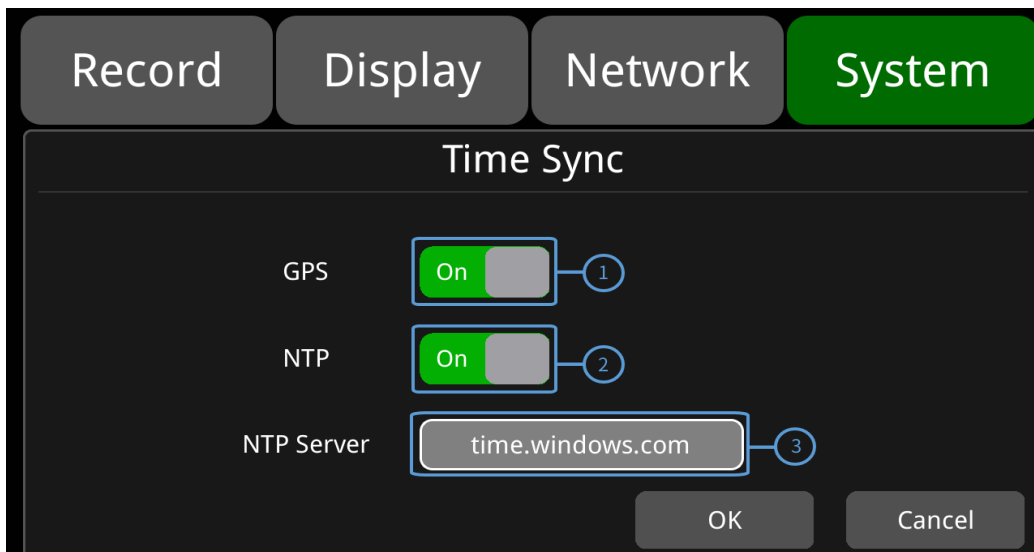

"Time Sync" default configuration as shown above.

### Time Snyc Setup:

Go to "System -> Date &Time ->Time Sync->Setup" page.

- ① GPS: Set GPS to ON/OFF.
- ② NTP: Set NTP to ON/OFF.
- ③ NTP Server: Show the URL of the NTP Server.

Application scene	usage
GPS:Off and NTP:Off	Set the time zone and daylight saving time first, then set the date and time
GPS:On or NTP:On	Time zone and daylight saving time must be set, no need to set date and time

Note: when "Time Sync"->"GPS" or "Time Sync"->"NTP" is ON, the time zone and daylight saving time must be set; if the time zone is not set, GPS and NTP will change the system time to the default East 8 zone time, resulting in abnormal device time.

### DST Setup:

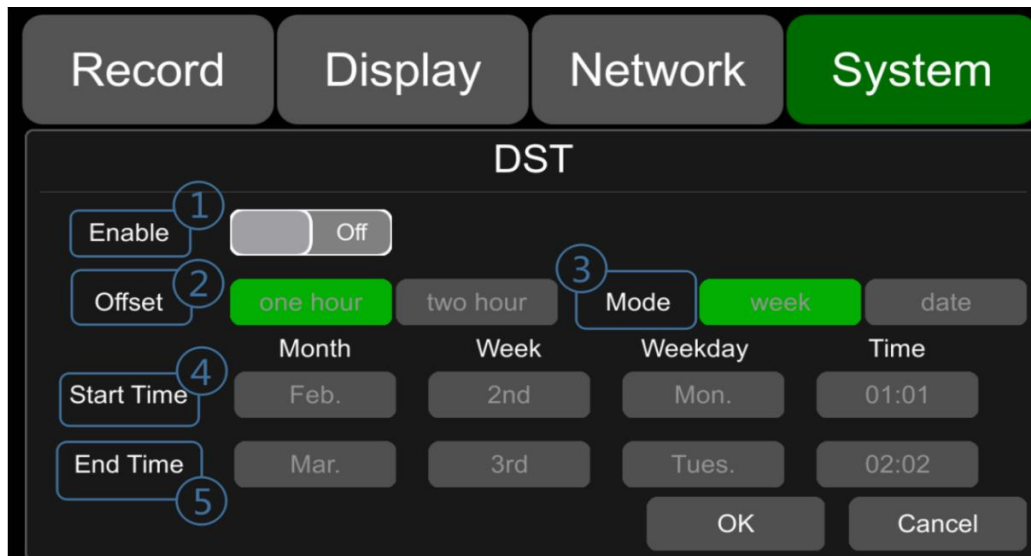

"DST" default configuration as shown above.

Go to "System -> Date &Time -> DST-Setup" page.

- ① **Enable:** Set DST setting to ON/OFF.
- ② **Offset:** Adjust the offset after enabling DST.
- ③ **Mode:** Select the mode of DST (setup DST according to week or date).

④ **Start:** Set start time of DST.

⑤ **End:** Set end time of DST.

## 11.4 Scheduled Recording



	Enable	Start	End	Weekday
Schedule 1	<input type="checkbox"/> Off	00:00	01:40	Setup
Schedule 2	<input type="checkbox"/> Off	00:00	01:40	Setup
Schedule 3	<input type="checkbox"/> Off	00:00	01:40	Setup
Schedule 4	<input type="checkbox"/> Off	00:00	01:40	Setup

The default configuration is shown above.

**Enable:** Set scheduled recording ON/OFF.

**Start:** Set start time of scheduled recording.

**End:** Set end time of scheduled recording.

**Weekday:** Set scheduled recording by weekdays. Select the weekdays to set preset.

Scheduled Recording:

- Support up to four appointed tasks. The recording duration is counted in minutes.
- Recording time can overlap.
- The start time of scheduled recording must be set ahead of the end time.

## 11.5 Exception



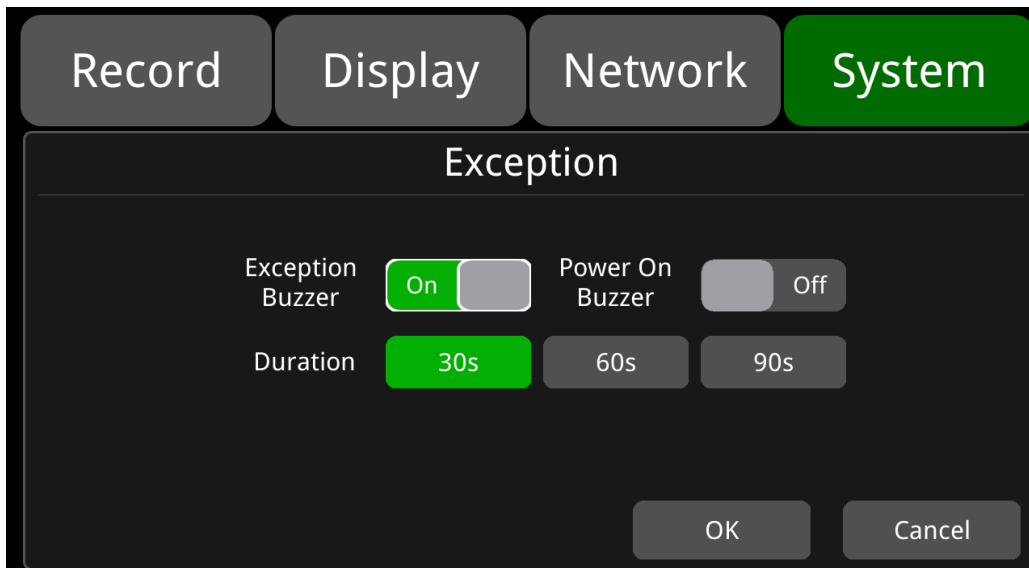

The default configuration is shown above.

**Exception Buzzer:** Set the exception buzzer to ON/OFF.

**Power On Buzzer:** Turn on the buzzer can be set to ON/OFF

**Duration:** Set the duration time of the buzzer.

## 11.6 ACC Settings

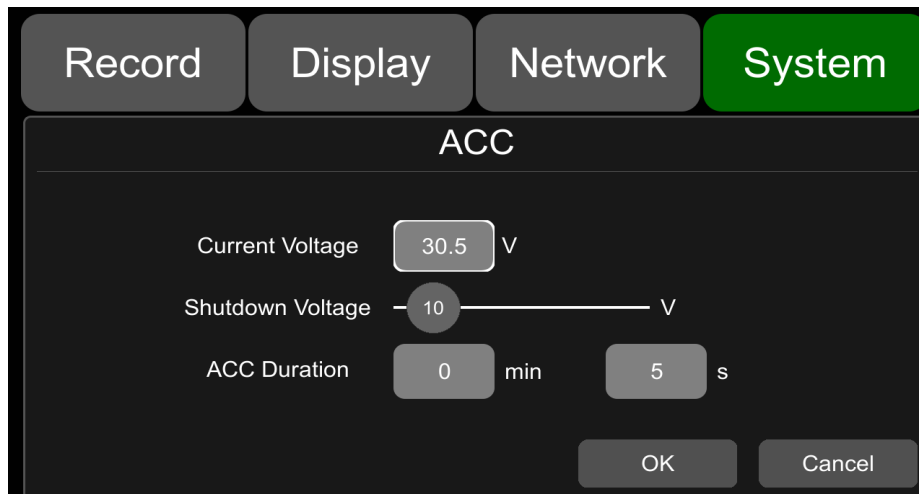

The default configuration of "Shutdown Voltage" and "ACC Duration" is shown above.

**Current voltage:** Voltage of the working DVR.



**Shutdown voltage:** When the current or voltage is lower than the shutdown voltage, the device will shut down automatically. When the current or voltage is higher than the shutdown voltage, the device would work properly. When the current or voltage is lower than shutdown voltage and the device is shut down, users could disconnect the VCC of the device for one minute, then the device will come back to work for one minute. During this time users can change the value of shutdown voltage.

**ACC Duration:** The device will continue recording for a few seconds after ACC is disconnected. ACC delay time can be set to be 5s to 60min.

ACC	Min.	Max.	Default
Shutdown Voltage(V)	9	24	10
ACC Duration(s)	5	360	5

## 11.7 Alarm Information Setting

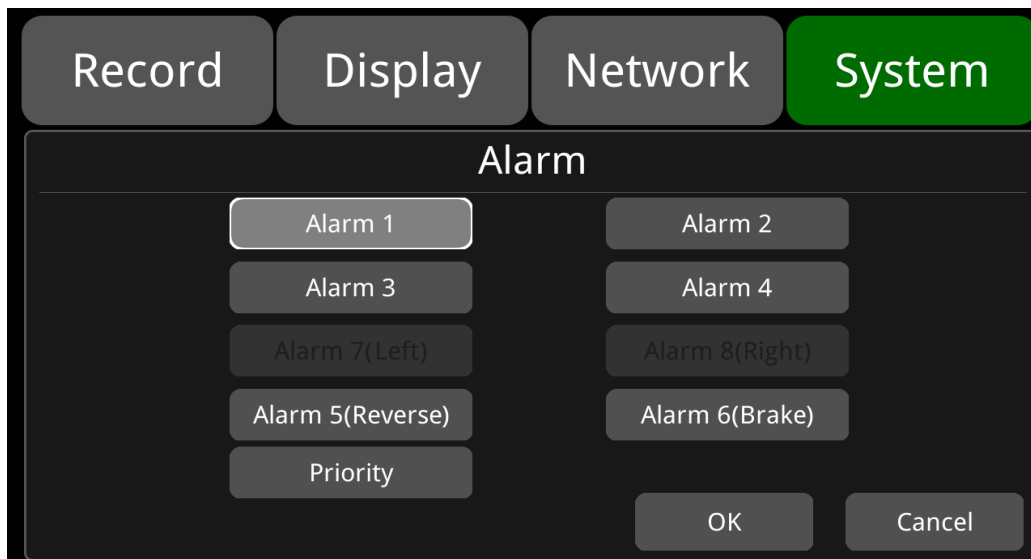

**Alarm 1~Alarm 4:** Customized alarm recording.

**Reverse:** Reversing alarm recording. .

**Brake:** Brake alarm recording.

**Priority:** Set priorities for Alarm1~Alarm4, Reverse, Brake.

When different types of alarm are triggered at the same time, alarms with the highest priority will work first.

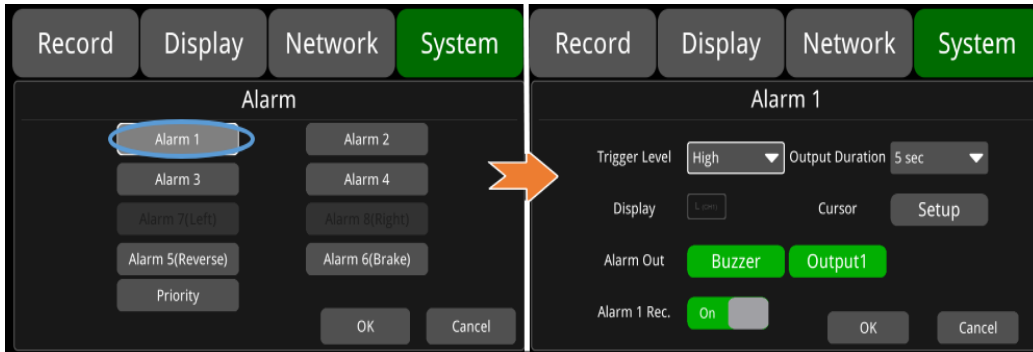

“Alarm 1” default configuration as shown above.

**Trigger Level:** There are 3 options of Trigger Level. The options “Low” and “High” are used for turning on alarm function. “Low” is generally used for debugging while “High” will be selected to turn on alarm function for on-road use. “Off” means turning off alarm trigger function.

**Output Duration:** "Display" "Curser" "Alarm Out" effect duration. Output Duration the options are 0sec, 5sec, 10sec, 30sec, 60sec, 5min, 10min, 30min, 60min, Always.

**Alarm Out-Buzzer:** Switch ON or OFF of the Alarm Out-Buzzer. The default buzzer sounds for 5 seconds.

**Alarm Out-Output1:** Set it ON, then 12V level output would come from the alarm wire of Output 1.

**Alarm 1 Rec.:** Alarm 1 event recording switch, the recording duration is set in [System]-> [Record]-> [Event Duration].

**Display:** When the alarm is triggered, the selected split mode will be displayed; the available split modes are shown in the figure below.

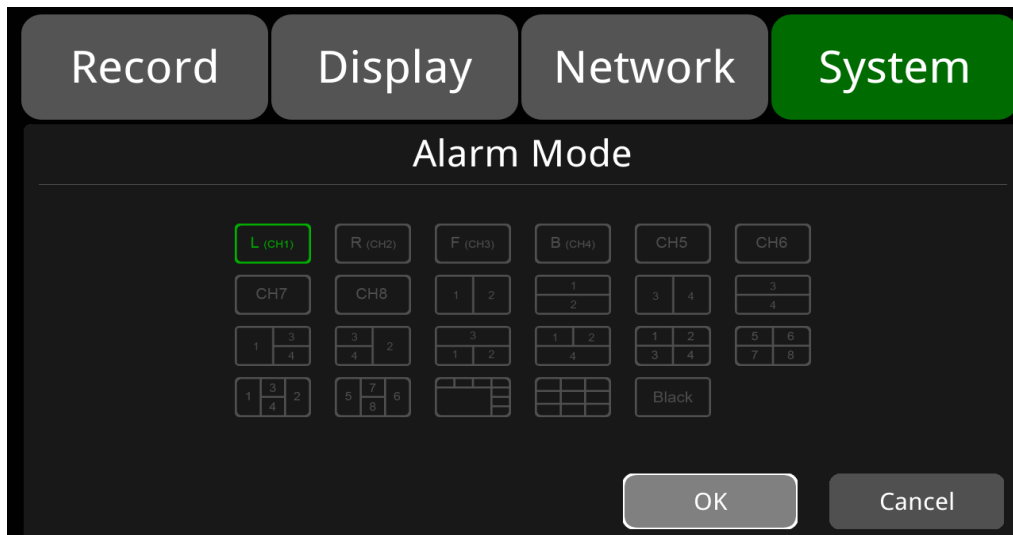

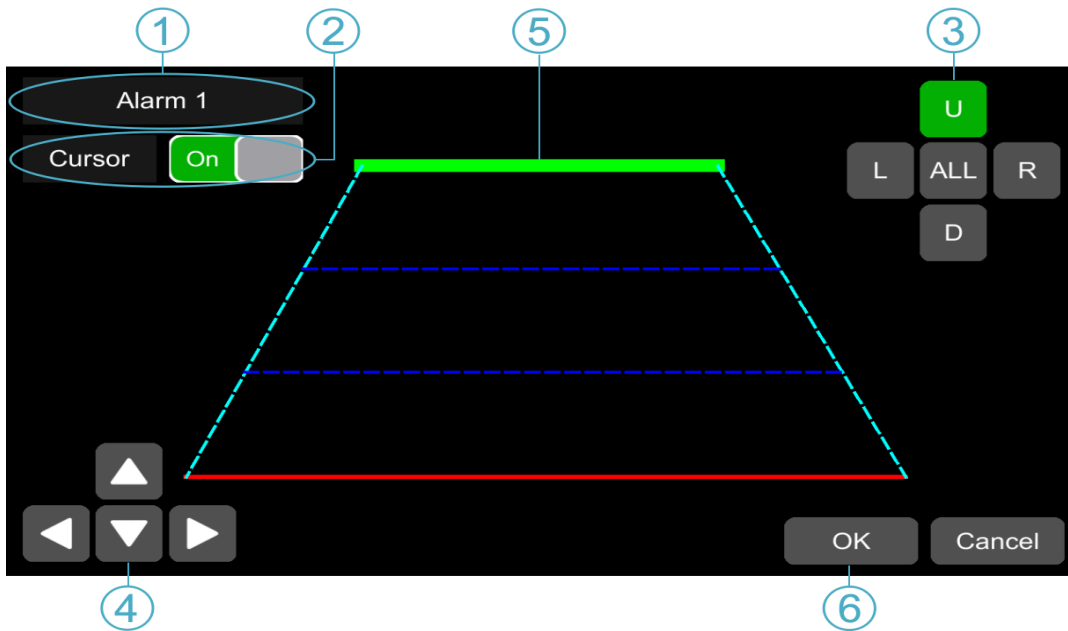

**Cursor:** It is “OFF” by default. The picture below shows the open state.

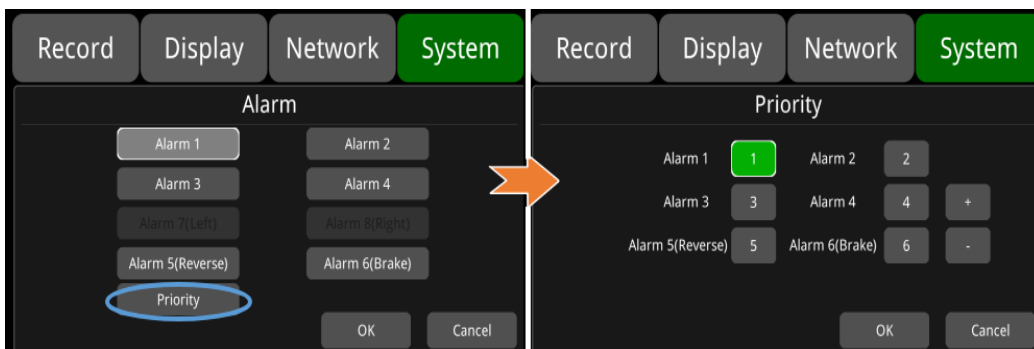

- ① Camera name of the alarm-triggered channel.
- ② Touch this button to turn on/off cursor.
- ③ Line selecting: There are five lines to be selected. Line U (up), Line D (down), Line L (left), Line R (right) and ALL. The button turns green if selected. You can use remote control to operate.
- ④ There are four directions to adjust the shape of the cursor, Up, Down, Left and Right.  
 If Line U (the green one) or Line D (the red one) is selected, the selected line can be moved with these directions.  
 If Line L or Line R is selected, the top point of the selected line can be moved to left or right with Direction Up and Direction Down, and the bottom point of the selected line can be moved to left or right with Direction Left and Direction Right.
- ⑤ Lines of cursor. The selected one will be thickened for three times. The two lines in the middle will not be processed.
- ⑥ Touch OK to save the settings and exit. Cancel to exit without saving any settings.

**Priority:** The default configuration is shown below.



 : Press this button, then the priority value of the selected alarm will be added by 1. The bigger the value is, the lower the priority will be.

 : Press this button, then the priority value of the selected alarm will be reduced by 1. The smaller the value is, the higher the priority will be.

- Alarms with higher priority will be triggered first.
- 1 is the highest priority, and 6 is the lowest.
- If two alarms A and B are triggered at the same time, and A's priority is higher than B's, then A will record first. After A finishes the recording, if B is still being triggered, B will then record. However, if B is no longer being triggered, it will not record.
- If alarm B is triggered while recording, if alarm A, whose priority is higher than B, is triggered then, B will not stop recording.

## 11.8 Update



- For Single Device

Step 1: format the SD cards in DVR, it will get the correct format to recognized by DVR; Copy the files to the USB disk or SD card/upgrade/package/local directory, ; insert the USB disk or SD card into the DVR.

Step 2: Power off the DVR and reboot it, then it will upgrade automatically. Or go to Menu -> System -> Update->Software, touch OK to confirm the upgrading. Both methods can start the upgrade process.

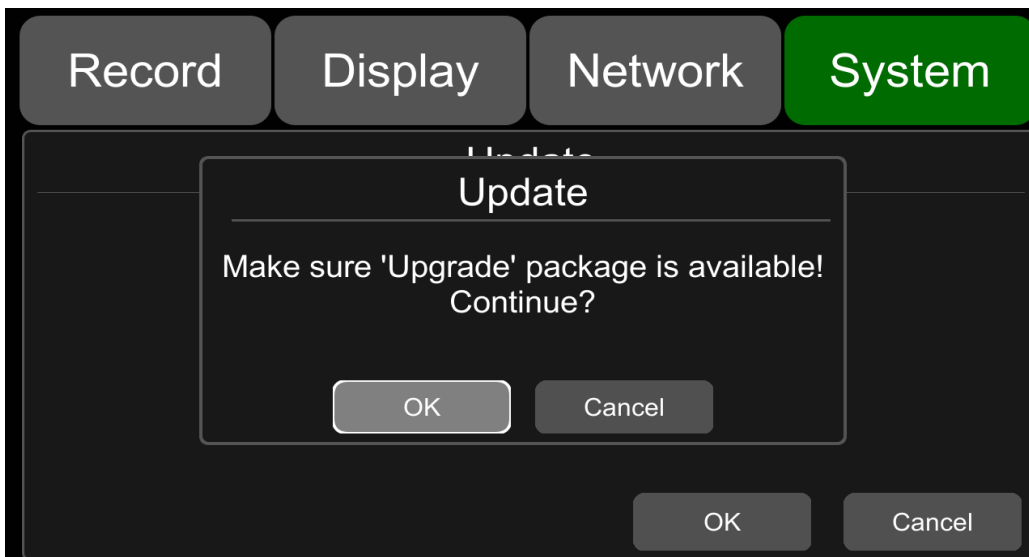

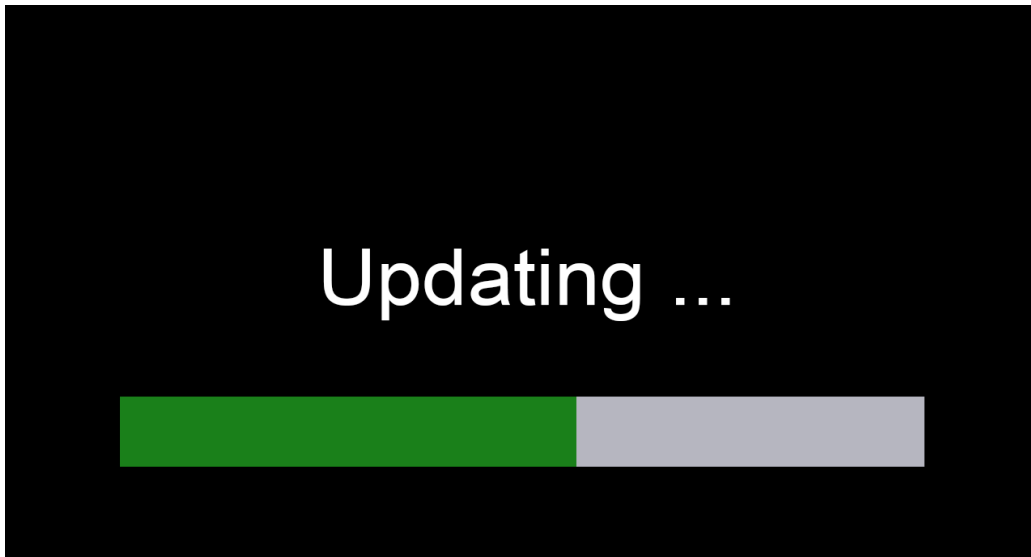

Step 3: When "Update success!" is shown on the display, the device will reboot automatically.

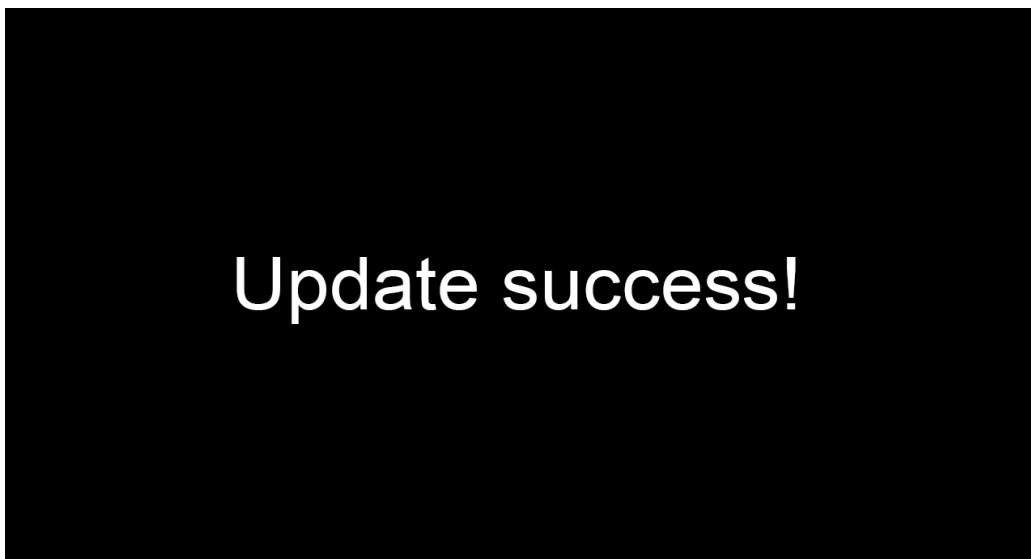

Step 4: After rebooting, please check if the version is the same as the one you copy into "upgrade" folder. Please go to Menu -> System -> Info to check it.

Note: After the upgrade is completed, the "dvxxx\_upgrade\_201xxxxxxxxx\_Rename" upgrade package in the USB disk or SD card /upgrade/packet/local will be deleted

- Remote Upgrade

Step 1: The device connects to server.

Step 2: Open the Windows client and log in.

Step 3: Find the license number of the target device in the device list of the client, right click and select “Update” to open the Batch Upgrades interface. If you need to upgrade more than one device, you can click the Add button to select other devices. The selected ones will be displayed on the device list to upgrade. If you want to remove devices from the list, please select them and click the Del button.

Step 4: Select the device to upgrade, and then click the Browser button to select the upgrade package “dvxxx\_upgrade\_201xxxxxxxxx\_Rename”.

Step 5: Click the Start button to upload the upgrade package. When uploading is finished, the device will start upgrading automatically. If it failed to upload, the reason of failure will be displayed in the Remark column in the list.



## 11.9 Configuration



Configuration Import: Import the configuration information from the flash memory device, and place the configuration file in the sd/export\_file/config directory.

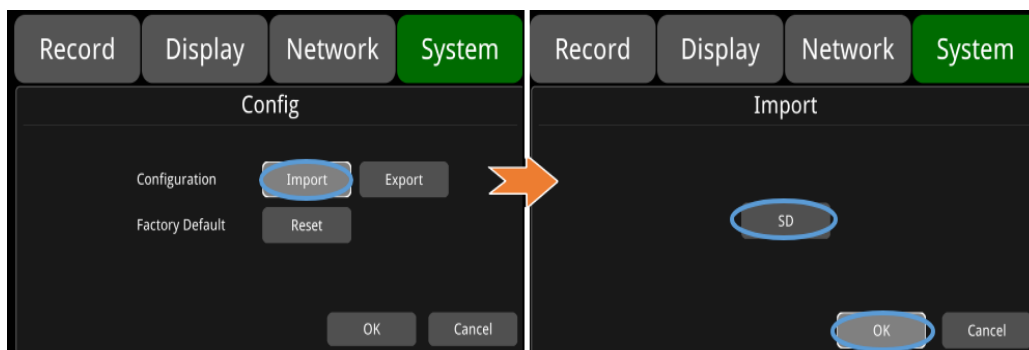

**Configuration Export:** Export Log to SSD, SD card or USB memory flash devices.

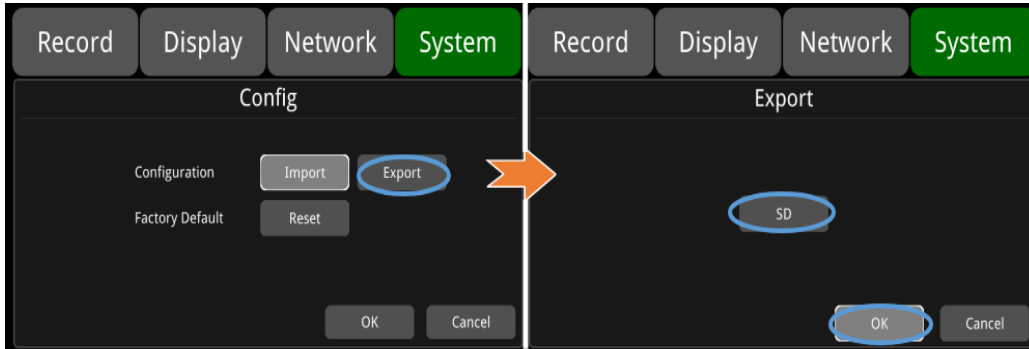

**Factory Default:** Press Reset to restore factory settings.

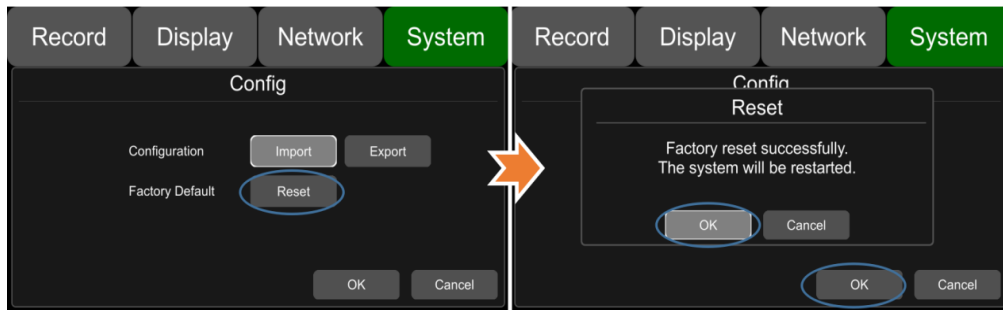

## 11.10 Application Setting

AI: Algorithm. ADAS (Advanced Driving Assistance System), DMS (Driver Monitoring System),  BSD (Blind Spot Detection) and APC (Automatic Passenger Counting) algorithms can be set. By default, these 4 channels are empty. You can manually select the algorithm of the corresponding channel. After selecting, the machine will automatically restart, and you can configure the corresponding function after reboot. In addition, one channel each can be selected for ADAS and DMS. Up to four channels can be used simultaneously for BSD, and two channels can be used simultaneously for APC. All four algorithms can be used together.

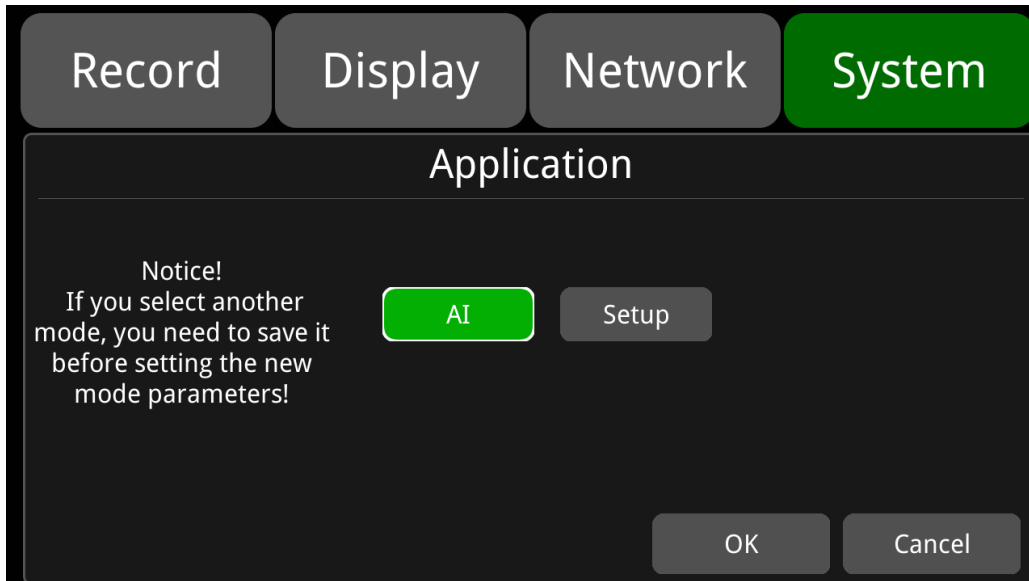

## ADAS Algorithm

FCW, i.e., forward collision warning algorithm, and PDS, i.e., pedestrian detection system are included.

The following figure shows the default configuration interface:

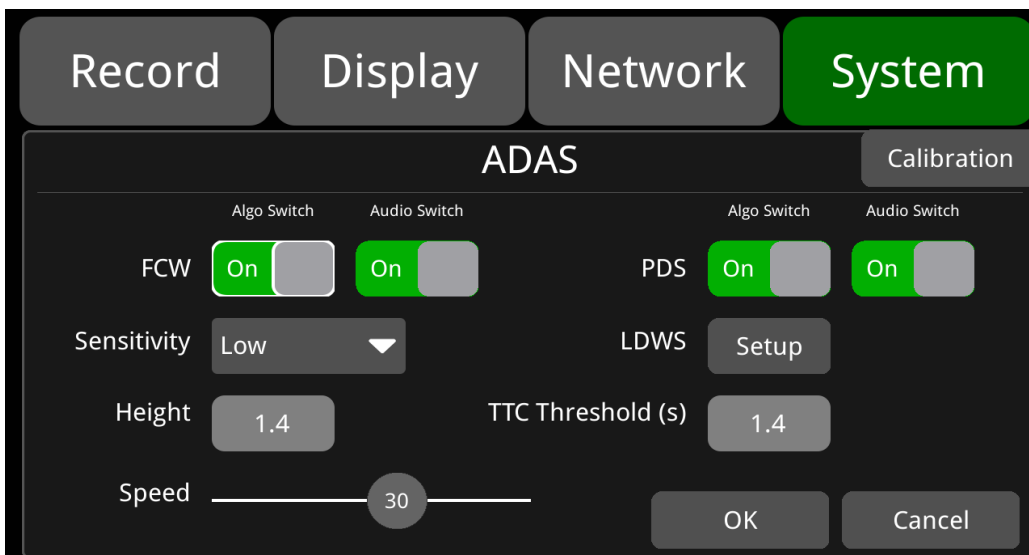

**Algo Switch:** If it is set to “On”, when the expected collision time TTC Threshold (s) is less than the configured time, the forward collision alarm and pedestrian detection alarm will be triggered. If set to OFF, the alarm will not be triggered even if the expected collision time TTC Threshold (s) is less than the configured time.

**Audio Switch:** If it is set to “On”, audio warning will be sent when forward collision alarm and pedestrian detection alarm are triggered; if it is set to OFF, no audio warning will be activated when forward collision alarm and pedestrian detection alarm are triggered.



**TTC Threshold(s):** Time-to-collision. The default value is 1.4.

**Sensitivity:** Sensitivity level. There are three levels, Low, Medium, and High, with the default of Low.

**Speed:** Set the FCW working speed value. For example, when it is set to 5, it indicates that the FCW can only start when the vehicle speed is larger than or equal to 5km/h. The default value is 30.

**FCW installation:** Installed in front of the windshield, with a height of approximately 1.4m.

**FCW Installation Diagram:** Based on the vehicle models below, select the glass region near the red dot as the mounting location and wipe it clean with a duster. Make sure to install the camera in a horizontal position. If FCW needs to be mounted in other positions, please ensure that the windshield wiper can reach the glass that is facing the camera, so the part that camera sees through can remain clean.



**Calibration:** Parameter calibration. Adjust the camera angle to fix the camera when the road and sky may each occupy half of the screen, as shown below:

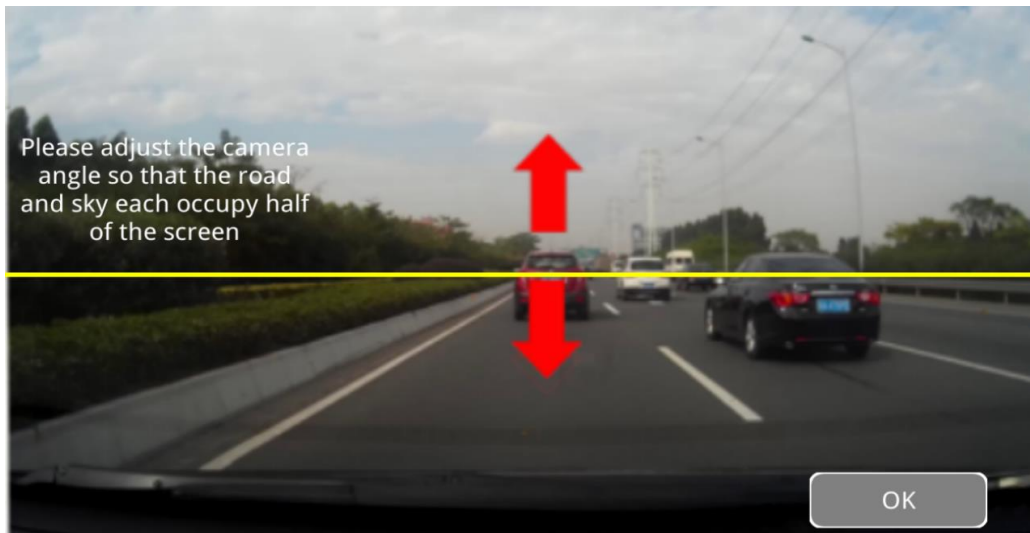

**LDWS Algorithm:** Lane departure warning. In the event of a lane departure, the first channel will display the corresponding screen. The following figure shows the default configuration interface:

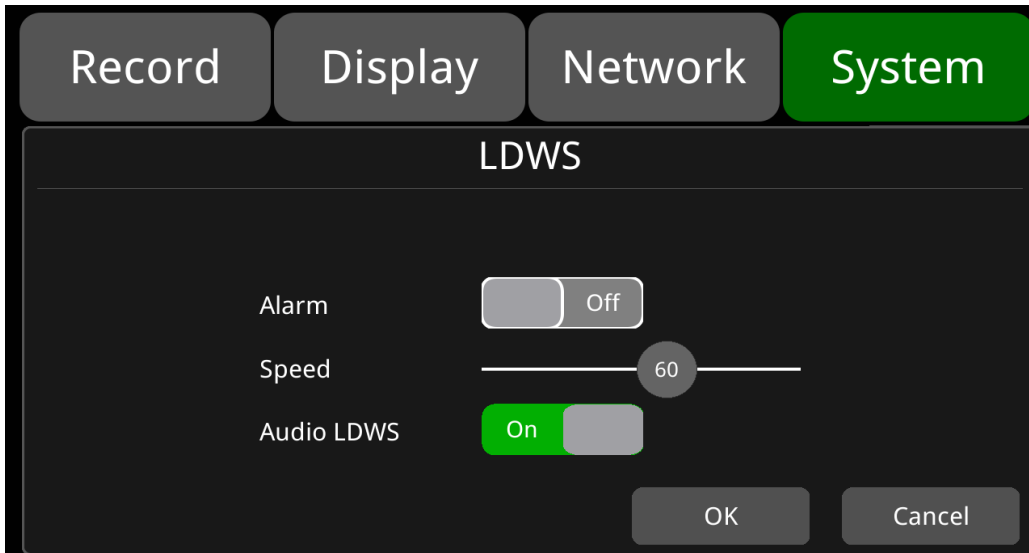

**Alarm:** If set to “On”, when the current speed is greater than the set working speed and the vehicle departs from the lane, lane departure alarm recording will be triggered; when set to Off, even if the current speed is greater than the set working speed and the vehicle departs from the lane, the lane departure alarm recording will not be triggered. Alarm is Off by default.

**Speed:** Set the operating speed value of the Lane departure algorithm. For example, if it is set to 60, the lane departure algorithm can only be started when the vehicle speed is greater than or equal to 60km/h. The default is 60.

**Audio LDWS:** If it is set to “On”, audio warning will be sent when the lane departure alarm is triggered; if it is set to Off, no audio warning will be generated when the lane departure alarm is triggered. Audio LDWS is ON by default.

## DMS Algorithm

Driver monitoring system. When the driver is being monitored, the second channel will display the corresponding screen. The following figure shows the default configuration interface:

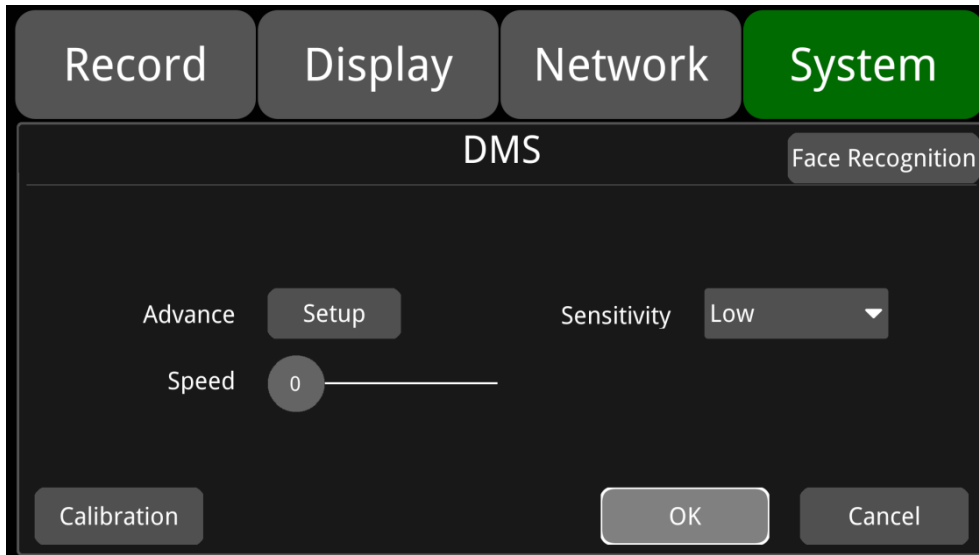

Distraction type selection and default configuration.

<b>Alarm Type</b>	<b>To set ON</b>	<b>To set OFF</b>
DMS_Fatigue	When the driver's fatigue is detected, an alarm recording will be triggered, and there will be a voice announcement.	No fatigue alarm.
DMS_Distractio	When the driver's distracted is detected, an alarm recording will be triggered, and there will be a voice announcement.	No distraction alarm.
DMS_No Driver	When the driver's absence from the seat is detected, an alarm recording will be triggered, and there will be a voice announcement.	No driver alarm.
DMS_Smoking	When the driver's smoking is detected, an alarm recording will be triggered, and there will be a voice announcement.	No smoking alarm.
DMS_Calling	When a phone call of the driver is detected, the alarm recording will be triggered, and there will be a voice announcement.	No phone call alarm.
DMS_NoSeatBelt	A "no seat belt" alarm and a voice broadcast will be triggered when the driver is detected not wearing a seat belt.	No "no seat belt" alarm and voice broadcast.
DMS_SunGlass	An alarm recording will be triggered when the driver is detected wearing sunglasses.	No "wearing sunglasses" alarm.
DMS_YAWN	An alarm recording will be triggered when the driver is detected yawning.	No yawning alarm.
DMS_NoMask	An alarm recording will be triggered when the driver is detected not wearing a mask.	No "not wearing a mask" alarm
DMS_NoShelter	An alarm recording will be triggered when the camera is blocked.	No camera blocked alarm

<b>Options</b>	<b>Description</b>
Algo Switch	Algorithm alarm switch.
Audio Switch	Voice alarm switch.
Sensitivity	Sensitivity level. There are three levels, Low, Medium, and High. The default is Low.
Speed(km/h)	To set the DMS working speed value. For example, if it is set to 60, the DMS algorithm can only be activated when the vehicle speed is greater than or equal to 60. The default is 0.

The default values for the DMS parameters are as follows:

<b>Alarm type</b>	<b>Default</b>
DMS_Fatigue	On
DMS_Distracton	On
DMS_No Driver	Off
DMS_Smoking	On
DMS_Calling	On
DMS_NOSeatBelt	Off
DMS_SunGlass	Off
DMS_YAWN	On
DMS_NoMask	Off
DMS_Shelter	On
Sensitivity	Low
DMS Work Speed(km/h)	0
Audio Switch	On (Exception: Off for DMS_NOSeatBelt/DMS_NoMask)

Alarm Type	Alarm Duration/Threshold	Min.	Max.	Default
Fatigue	Time (s)	1	6	3
	Threshold	1	99	30
Distraction	Time (s)	1	9	5
	Threshold	1	99	35
NoDriver	Time (s)	1	30	15
	Threshold	/	/	/
Smoking	Time (s)	1	20	2
	Threshold	1	99	50
Calling	Time (s)	1	5	3
	Threshold	1	99	60
Times (s)	Time (s)	1	30	10
	Threshold	1	99	50
SunGlass	Time (s)	1	30	10
	Threshold	/	/	/
YAWN	Time (s)	1	5	5
	Threshold	/	/	/
NoMask	Time (s)	1	15	10
	Threshold	/	/	/
Shelter	Time (s)	1	30	5
	Threshold	/	/	/

**DMS Installation:**

DMS should be installed in a proper location. It is required to install it on the driver's console at a distance of 0.8~1.2M from the driver and at an approximate angle of +/-30 degrees from the driver's front view, as shown in the figure below. Installation and calibration need to be done simultaneously, so it is recommended to have a manager present to adjust, calibrate the device and guide the driver during the relevant operations.

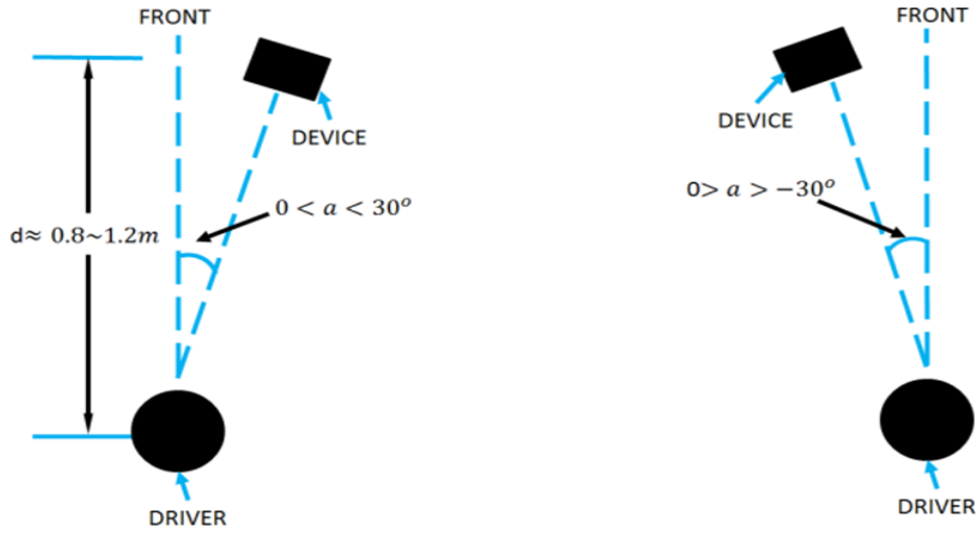

**Calibration:** Parameter calibration. Calibrate your face by aligning it with the square blue (default) calibration box displayed on the screen. Once aligned, a green box will appear at the position of the face, and then click the Start button to proceed. 2~3s later, a pop-up box will appear with the message "Calibration successful!", accompanied by voice prompts. To exit the calibration interface, simply click the OK button in the pop-up box. As shown below:

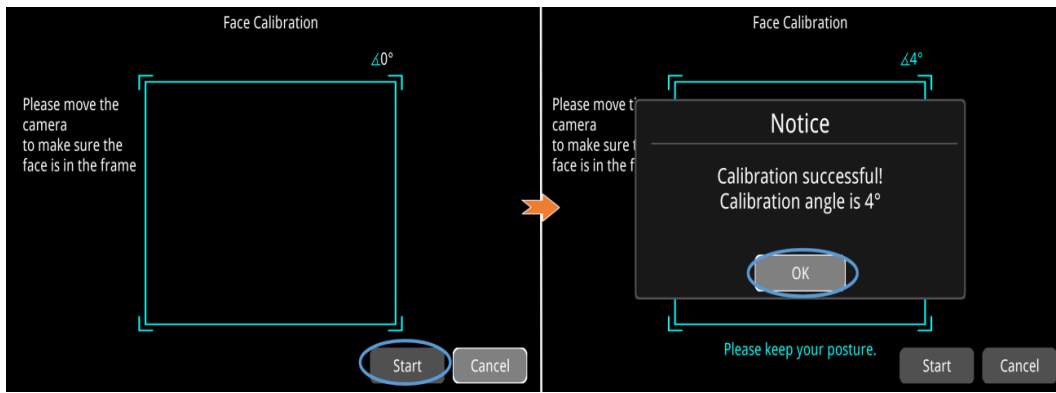

Align your face with the calibration box displayed on the screen, and then click the Start button to proceed. If your face moves out of the box during calibration, the box will turn yellow. After 2~3s, a pop-up box will appear indicating “Calibration failed!”. Click the OK button in the pop-up box to restart the calibration. As shown below:

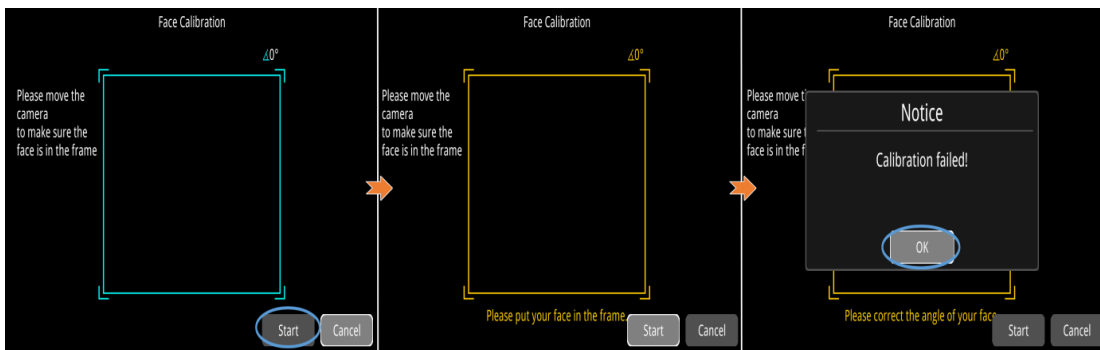

Align your face with the calibration box displayed on the screen, and then click the Start button to proceed. If the face deflects from side to side during calibration, when the angle exceeds the range of [-30, 30], the box will turn red, and the voice prompts will indicate “too left” or “too right”. After 2~3s, a pop-up box will appear indicating “Calibration failed”. Click the OK button in the pop-up box to restart the calibration. As shown below:

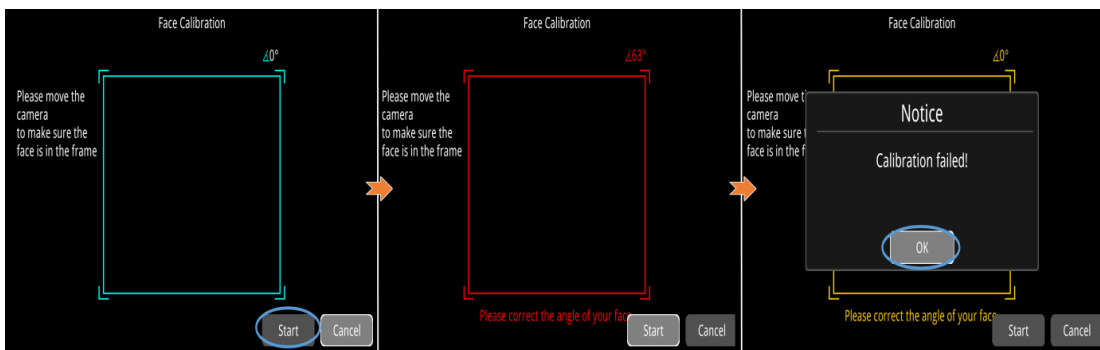

After a calibration failure, simply click the Start button again to initiate the calibration process.



**Face Recogniton** : Face recognition

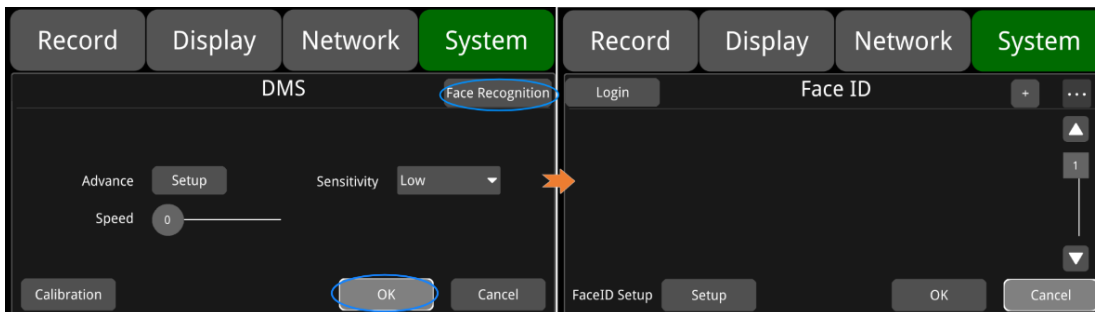

+: Add a human face, as shown in the figure below. Click OK after entering the name, and aim your face at the camera. Click the Start button, and move your face up, down, left and right to input the data. Then a window will pop up to notify the success or failure of input with a voice message.

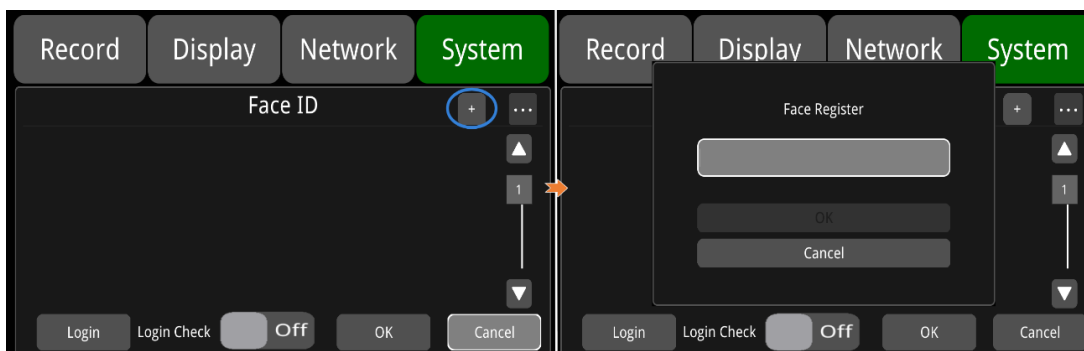

...: Import, export and delete functions. As shown in the figure below, check the imported face photo and click Import/Export/Del to import, export or delete the selected photo. The exported files are stored under the "faceID" path on the disk.

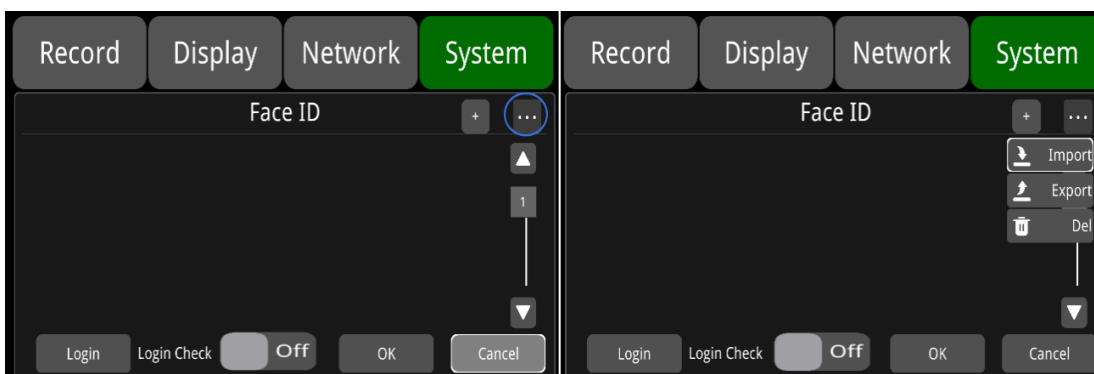

**Login:** Click to log in through face recognition.

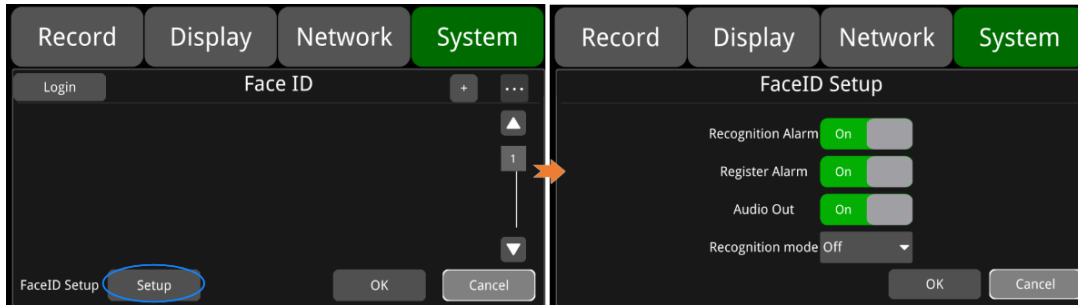

**Recognition Alarm:** Face recognition alarm. It is On by default.

**Register Alarm:** Face registration alarm. It is ON by default.

**Audio Out:** Voice alarm switch. It is ON by default.

**Recognition mode:**

Face recognition mode. There are three available options.

**Power On:** This option enables automatic face recognition when the device is powered on. Each time you turn on the device, it will initiate face verification and provide a voice prompt saying "again to login". When you position your face in front of the camera, there will be a prompt stating "login success". If no face is detected or a new face is detected, there will be a voice prompt saying "login fail". This prompt is only given once when the device is powered on.

**Auto:** This option allows face recognition to occur every 5 minutes automatically. The device will initiate face verification at regular intervals without any manual intervention.

**Off:** This option disables the face verification feature. No face recognition will be performed. It is Off by default.

## BSD Algorithm

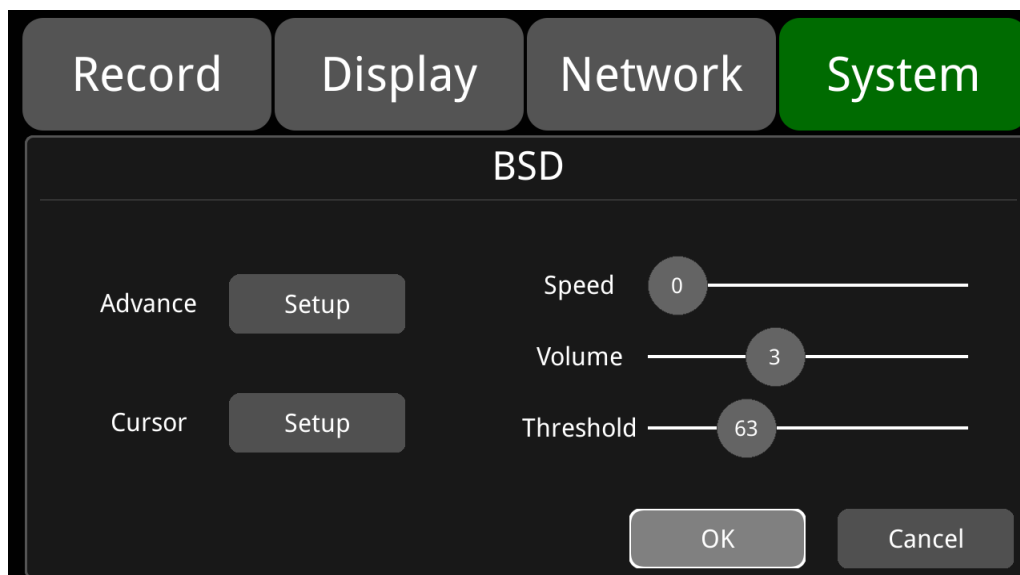

**Advance:** Set the range covered by the BSD algorithm and the related alarm settings as shown below:

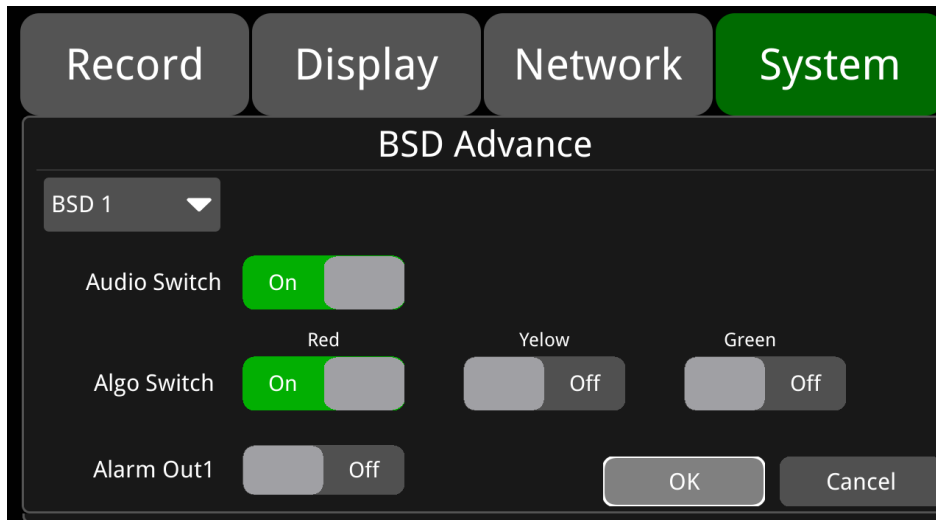

**Audio Switch:** Video alarm switch. Set to “On” for alarm sound output, off for none. The default is ON.

**Algo Switch:** Alarm zone switch. There are three optional switches, red, yellow and green. Red is ON by default.

**Alarm Out1:** Level output switch. If it is turned on, Alarm Out1 will output a high level after a BSD alarm is triggered.

**Speed:** Set the speed threshold for BSD function. When set to 5, the BSD algorithm will activate only when pedestrians are walking at a speed of 5km/h or higher. The default value is 0.

**Volume:** Adjust the volume of the audible and visual alarm. The default value is 3.

**Threshold:** Pedestrian detection and alarm precision selection.

	Min.	Max.	Default
Speed	0	100	0
Volume	0	8	3
Threshold	50	99	63

**Cursor:** It is ON by default. The figure below shows the “On” state.

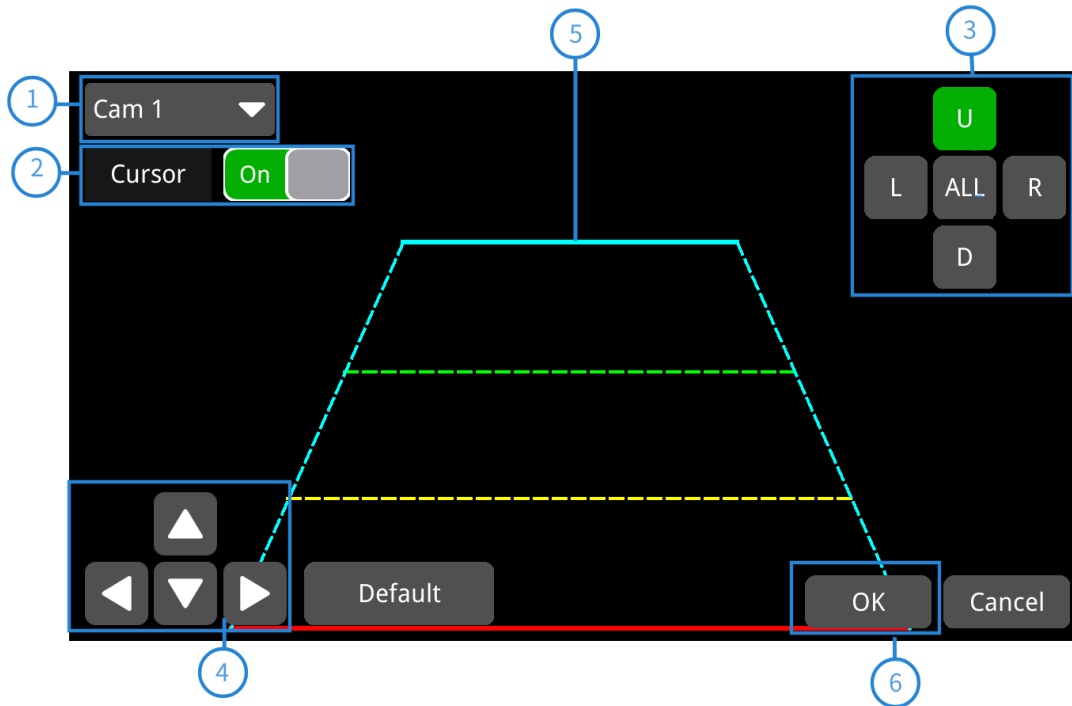

- ① Camera name of the alarm-triggered channel.
- ② Touch this button to turn on/off the corresponding cursor.
- ③ Line selecting: There are five lines to be selected. Line U (up), Line D (down), Line L (left), Line R (right) and ALL. The button turns green if selected. You can quickly operate with “1, 2, 3, 4, 5” on the remote control.
- ④ There are 4 direction to adjust the shape of the cursor, Up, Down, Left and Right.  
 If Line U (the green one) or Line D (the red one) is selected, the selected line can be moved as a whole with these direction buttons.  
 If Line L or Line R is selected, the top point of the selected line can be moved to left or right with Direction Down or Direction Up, and the bottom point of the selected line can be moved to left or right with Direction Left or Direction Right.  
 If ALL is selected, all the lines can be moved as a whole in these four directions.
- ⑤ Lines of cursor: The selected one will be thickened for three times. The middle two lines will not be processed.
- ⑥ Touch OK to save the settings and exit. Cancel to exit without saving any settings.

## APC Algorithm

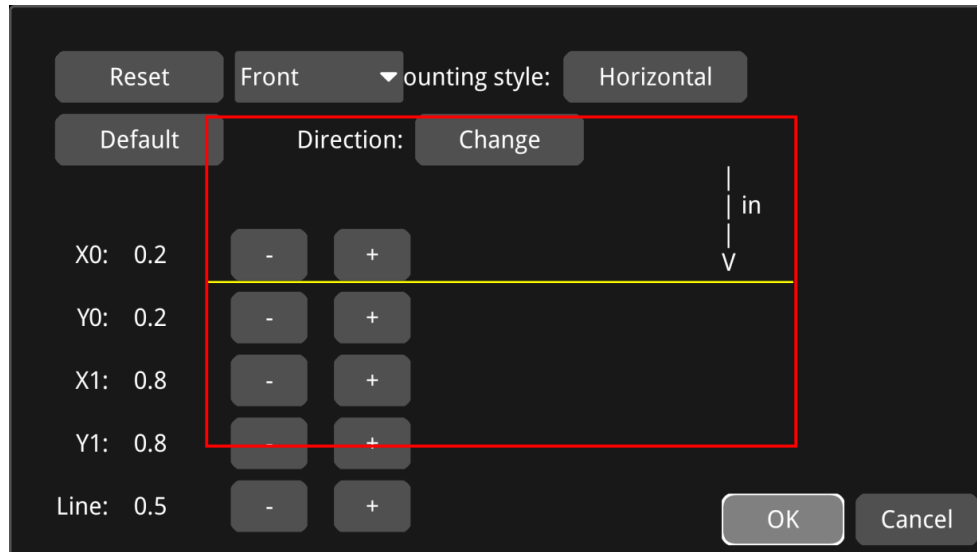

**Reset:** Click to revert to the previous settings.

**Default:** Click to revert to the default settings.

**Counting style:** To choose the direction of the yellow line - a line used to detect passengers entering and exiting, in the detection frame. If Horizontal is selected, it will become a horizontal line, which detects passengers entering and exiting the vehicle in an up-and-down direction within the detection frame. Similarly, if Vertical is selected, it will become a vertical line detecting passengers entering and exiting the vehicle in a left-and-right direction within the detection frame.

**Direction:** Select the direction in which you want to detect entry and exit.

**X0:** Adjust the value for the position of the left border. "-" is to move left, and "+" is to move right. The default is 0.2.

**Y0:** Adjust the value for the position of the top border. "-" is to move up, and "+" is to move down. The default is 0.2.

**X1:** Adjust the value for the position of the right border. "-" is to move left, and "+" is to move right. The default is 0.8.

**Y1:** Adjust the value for the position of the bottom border. "-" is to move up, and "+" is to move down. The default is 0.8.

## 11.11 System Info



System Info: Software version number.

The image shows a dark-themed dialog box with a title bar containing four tabs: 'Record', 'Display', 'Network', and 'System'. The 'System' tab is highlighted in green. Below the tabs, the word 'Info' is centered. The main content area displays three lines of text: 'SYS Version: 20190613.5432', 'MCU Version: 2019051410', and 'Device ID: no uid'. An 'OK' button is located in the bottom right corner.

Info	
SYS Version:	20190613.5432
MCU Version:	2019051410
Device ID:	no uid

OK

# 12 FAQ

## 1) The System Can't Start up?

Check the power connection. Please follow the steps below to check the power connection:

- ① Check the input power: if the power wire is connected correctly, if the ground wire is connected to the battery, and if the fuse on the power wire is in good condition.
- ② Check if the voltage of the ACC signal wire is higher than 6V.
- ③ Check if the input voltage of the device is higher than the shutdown voltage set on the screen of the device.

## 2) The Device Keeps Restarting?

Please follow the steps below to check:

- ① Check if the supply voltage of DVR is insufficient. If it is lower than the start-up voltage, the device would restart repeatedly.
- ② Restart the device to see if it will work properly.

## 3) Unable to Recognize Disks?

- ① Check if the disk is in good condition and make sure that it is installed with good contact.
- ② The disk has been formatted by DVR.
- ③ Restart the device to see if it will work properly.

## 4) Unable to Recognize Cameras?

- ① Make sure the camera is good and the connection is correct.
- ② Reconnect all wires (e.g. extended wires) between cameras and the device.
- ③ Restart-the device to see if it will work properly.

## 5) GPS Abnormal?

Check if the GPS antenna is properly installed.

# 13 APPENDIX







## APPENDIX I : Abbreviation & Description

Rec.	Record	LED	Light Emitting Diode
G- Force	Accelerometer sensor	SD	Secure Digital Memory Card
GPS	Global Positioning System	USB	Universal Serial Bus
Wi-Fi	Wireless-Fidelity	ALM	Alarm
Cam	Camera	VLOSS	Video Loss
AVI	Audio Video Interleaved	COMM	Communication
OSD	On-Screen Display	ERR	Error
APN	Access Point Name	MEM	Memory
DHCP	Dynamic Host Configuration Protocol	MMSHOW	Media Player
SSID	Service Set Identifier	FTP	File Transfer Protocol
IP	Internet Protocol	DVR	Digital Video Recorder
MAC	Media Address Control	IR	Infrared Radiation
RSSI	Received Signal Strength Indication	SYS	System
SSD	Solid State Drive	DST	Daylight Saving Time





## PENDIX II: Accessories

Standard Table:

Parts	Quantity	Description	Parts	Quantity	Description
	1.default	9 PIN power cable		1.default	Remote control
	1.default	DVR lock keys		1.default	6 PIN to RJ45
	1.default	10 PIN alarm wire		1.default	three-in-one antenna (2G-3G-4G-Wi-Fi-GPS)

Optional Accessories Table:

Parts	Quantity	Description	Parts	Quantity	Description
	1,optional	VGA, 10 PIN to 15 PIN cable		1,optional	10-inch touch screen monitor

## APPENDIX III: Compatibility Storage List

### SATA 3.0 SSD

Name	Description
SSD 32GB	MLC,TS32GSSD420I,-45°C~+85°C
SSD 64GB	MLC,TS64GSSD420I,-45°C~+85°C
SSD 128GB	MLC,TS128GSSD420I,-45°C~+85°C
SSD 256GB	MLC,TS256GSSD420I,-45°C~+85°C
SSD 512GB	MLC,TS512GSSD420I,-45°C~+85°C
SSD 1TB	MLC,TS1TSSD420I,-45°C~+85°C
SSD 128GB	3D TLC,TS128GSSD450K,0°C~+70°C
SSD 256GB	3D TLC,TS256GSSD450K,0°C~+70°C
SSD 512GB	3D TLC,TS512GSSD450K,0°C~+70°C
SSD 1TB	3D TLC,TS1TSSD450K,0°C~+70°C

### SD Card

Item Name	Description
32GB SD Card	32G, MLC,NCSXDAB-032G,Longsys,-25°C~+85°C
64GB SD Card	64G, MLC,NCSXJAB-064G ,Longsys,-25°C~+85°C
128GB SD Card	128G, MLC,NCSXJAB-128G ,Longsys,-25°C~+85°C
64GB microSD Card	64G,MLC,NCIXJBB-064G

**AMERICAN BUS VIDEO INC.**

Toll-Free 866.468.8042

Fax: 770.887.5944

AmericanBusVideo.com

SchoolBusCamera.com

VehicleVideoCameras.com

35+ Years of Mobile Digital Sales & Service Experience